

ANNUAL GUIDE TO 3D PRINTING

Make:



DREMEL'S
IDEA
BUILDER
REVIEWED

26
3D PRINTERS
TESTED!

*Local Motors
prints the future
for your driveway*



3D PRINT YOUR CAR*

*(YES, REALLY)

Behind the
Maker Tech
in Disney's
Big Hero 6

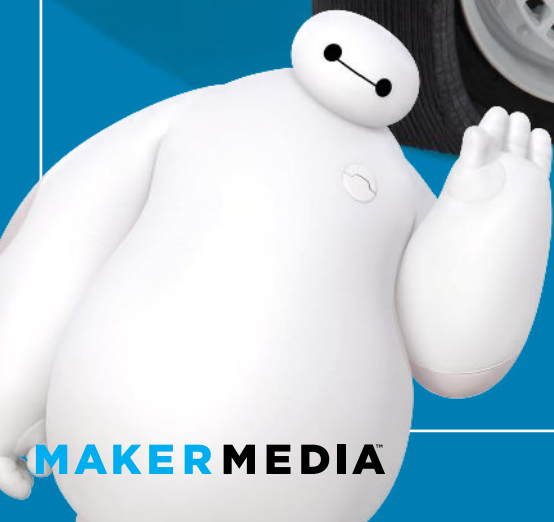



“RASPBERRY EYE” REMOTE SERVO CAM

Build a DIY pan/tilt webcam sentry and watch it from anywhere online.



MATT STULTZ
SOFTWARE DEVELOPER

Webcams are a fun and useful tool. Being able to control where they're looking remotely, though, takes their usefulness to a whole new level. Whether you're watching your pets while you're away or allowing friends to participate in an event from the other side of the world, a web-enabled camera puts the end user in control of the experience. The “Raspberry Eye” Remote Servo Cam project combines two very popular maker tools — a 3D printer and a Raspberry Pi — to show you how to create your own remote-access pan/tilt camera.

The Raspberry Pi provides a perfect base platform for creating Internet-connected devices. The Flask framework allows you to take your existing Python apps (the preferred language for developing applications on the Raspberry Pi) and add in an HTML template to provide a web page interface for the end user. This project has an HTML template document that's pretty bare bones, so it's easily understood by anyone who wants to look under the hood and also provides a good starting point if you want to customize it for yourself.

In order to send the video from the Raspberry Pi across the web, this project uses a software package called MJPG-streamer, which won't overwhelm the limited processing power of the Pi. The servomotors, which handle the pan and tilt of the camera, are controlled by the GPIO pins of the Raspberry Pi. A Python module called RPIO will make it easy to send the precise signals to the servos needed to set their position.

The “Raspberry Eye” Remote Servo Cam will get you started with basic snooping using your Pi, but there's a lot more you can do to extend the features. You can add Wi-Fi, create a custom enclosure for outdoor deployment or increase your stealth by concealing the project in a common household object like a cereal box or a book.

You'll be able to control the camera and view its output from a web browser on a computer that's on your local network. If you want to access “Raspberry Eye” Remote Servo Cam from the Internet, you can set up port forwarding on your router. However, be aware that there are no security or access control steps taken in the project — you're on your own for securing your “Raspberry Eye.”

Download the enclosure's design files from the project page and print out the parts. The smaller of the two pan/tilt arms will need to be printed with support material to allow the support arm to be printed correctly. If you don't have a 3D printer, you can order the parts through the link on the project page. While you are waiting for your parts, download the custom-made PiCam disk image from the project page and flash it to your SD card. Details on how to do this are linked on the project page.

Cut off the Micro-B end from one of the USB cables and strip 1" off of the outer insulation of the cable. Strip about 1/4" of insulation from the black and red wires that are inside. Trim away the cable shielding and cut the white and green wires flush with the end of the main cable insulation. Place heat-shrink tubing around each wire. Wrap and solder the bare end of the red wire around the short ends of both pins on one of your two-pin headers. Do the same thing with the black wire, wrapping and soldering it to both pins of your second two-pin header. Using your soldering iron or a heat gun, warm the heat-shrink tubing so that it contracts around the solder joints on the pins.

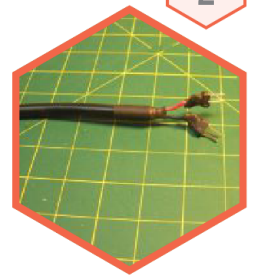

2

Run the servo cable from one of your servos down into the large rectangular hole on the top of the project case and push the servo into place. Use a screwdriver to tighten the two long mounting screws that were included with your motor. Run the connector from the second servo motor through the small rectangular hole in the top of the case, but don't mount this servo yet.

Build the “Raspberry Eye” Remote Servo Cam.

radioshack.com/DIT



PARTS

- Raspberry Pi single-board computer, RadioShack® 277-0196
- 3D-printed case and pan/tilt mechanism (Download the 3D files)
- SD card, 4GB or larger, RadioShack® 44-188
- Servomotors, micro (2), RadioShack® 273-0765
- Jumper wires and pin headers, RadioShack® 276-156
- USB charger, 2 port, RadioShack® 273-693
- USB cables, Micro B (2), RadioShack® 26-1416
- Raspberry Pi-compatible USB webcam
- Ethernet cable, RadioShack® 278-2012
- Heat-shrink tubing slightly wider than your USB cable, RadioShack® 278-1627
- Cable ties (aka zip ties or wire ties), RadioShack® 278-472

TOOLS

- Soldering iron, RadioShack® 64-211
- Solder, RadioShack® 64-005
- Wire strippers/cutters, RadioShack® 64-224
- Screwdriver, Phillips, RadioShack® 64-185
- File or sandpaper
- Afinia H-Series H480 3D Printer (optional)
RadioShack® 2770224



1

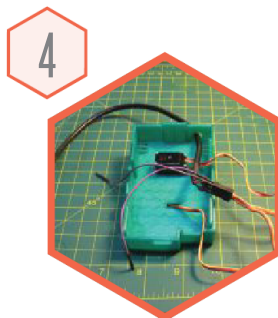

4



Run the jumper ends of the cable you built through the circular hole on the back of the case top. Plug the black header pins into both servo connectors, using the holes matching the brown wire from each servo. Plug the red header pins into the center connector hole on both servo connectors, matching the orange wires. Plug a purple jumper wire into each of the remaining holes on the servo connectors, matching the yellow wires. Push the tilt servo into the servo-shaped hole on the larger of the two printed arms. Screw the motor into place with the two long bundled screws.

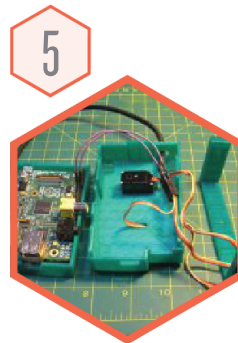

5

Plug the purple signal wire from the pan motor (the one attached to the project case) into pin 23 on the Raspberry Pi. Plug the signal wire from the tilt motor into pin 22 on the Raspberry Pi. Use the Ethernet cable to connect the Pi to your network. With the SD card inserted into the Pi, connect the USB power to the servos and the Raspberry Pi. Connect to the command line via SSH and run the included Python script to zero the motors to their home position before mounting. Shut down the Raspberry Pi and disconnect the power.

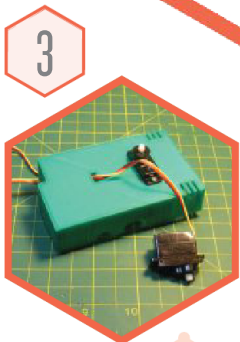

3

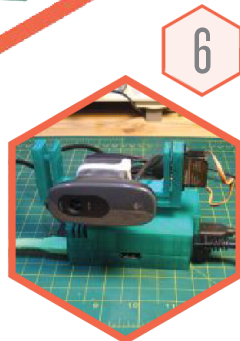

6

Attach the pan arm to the pan servo so that it is parallel to the long side of the case. The tilt servo should be on the same side as the USB and Ethernet ports. Run a zip tie through the bottom holes of the tilt arm, but don't zip it together yet. Press the tilt arm onto the servo gear on the pan arm. Screw it into place with the remaining small screw. Place the camera on the arm and secure it by tightening down the zip ties. Trim the zip ties so that they don't interfere with the tilt motion. Power up your project again and run the included software. From your computer, open <http://picam/> and you'll now see the output from your camera and use the control buttons to move the camera's view.



CONTENTS

Special Section

3D EVOLUTION

COLUMNS

Welcome **08**

Reader Input **10**

Punks and Makers **12**

How a music revolution powered the Maker Movement.

Wrongs and Rights **14**

For 3D printing, copy-right may not mean what you think it does.

Made on Earth **16**

Explore the amazing world of backyard technology.

Over the Top **112**

Do you have a 3D-printed concrete castle in your backyard? Well, why not??



12



72

22



ON THE COVER:

Local Motors CEO Jay Rogers in the 3D-Printed Strati. Photography by Erik Fuller

70

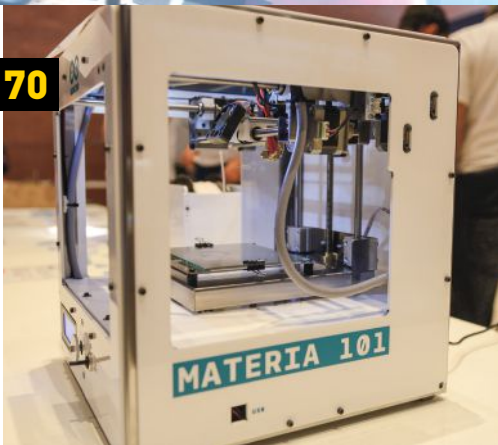

FEATURES

Heroes in the Making **22**

Disney's new animated crime-fighters are armed with ingenuity and high-tech tools.

Raspberry Pi Inside **26**

How the new compute module helps makers create embedded Linux products.

3D Evolution **30**

Desktop 3D printers are slowly evolving, but does performance meet the expectations of their consumer-ready facades?

What Is Print Quality? **34**

Testing to failure is more informative than a visual inspection.

Print-in-Place: The Additive Holy Grail **36**

Prepare to 3D print movable parts and joints.

3D Printer Buyer's Guide **38**

From hacker-friendly to consumer-ready, our experts review 26 3D printers.

Fused-Filament Findings **66**

Conclusions, trends, and the best 3D printers on the market today.

Arduino Gets Physical **70**

We take an early look at the Materia 101, Arduino's first foray into 3D printers.

Ones to Watch **71**

Will this be the year that SLS machines make it to the desktop?

Rapid Roadster **72**

It's drivable, with a fully 3D-printed body, and it's available soon.

Untether Your 3D Printer **74**

Host software lets you control your printer from anywhere on the web.

Stick It from the Start **76**

Tips for getting that great first layer and making sure your print stays put.

Rainbow Extrusion **77**

Use Sharpies to snazz up your prints cheaply and easily.

10 Great Short Prints **77**

Fast demo prints in 30 minutes or less.

You could stay on the fence,
or you could **fix it.**



Don't agonize about buying a welder. First, make sure it's **RED**. Second, make sure it's a **POWER MIG® 210 MP**. At 40 pounds, this machine can go anywhere, and with two voltage options, you can plug it in anywhere, too. The push button controls and LCD screen make setup a breeze, and with the versatility to weld Stick, MIG, Flux-Cored and TIG, you'll have all the welder you'll ever need, **for just \$999**. Get off the fence and get it done with the **POWER MIG 210 MP**.

www.lincolnelectric.com/210MP



AR14-29 © The Lincoln Electric Co. All Rights Reserved.



SKILL BUILDERS

Glowing Recommendations 98
Vintage components that add character to your creations.

Fun with Flexibles 102
Tips for 3D printing the stretchy stuff.

82

83

TOOLBOX

Tool Reviews 104
Recommendations for unique and useful maker tools, toys, and materials.

New Maker Tech 106
On the horizon for electronic accessories.

Books 107
Text tools for your bench or bedside table.

PROJECTS

Cyberpunk Spikes 78
3D-print these soft, flexible spikes and light them up with full-color programmable LEDs.

3D Printed Eyeglasses 82
Finally! Design and print your own custom specs.

3D Print Your Medical Scan 83
Prep CT images for printing, using only open-source software.

Boat Hitch Table 84
Make an adjustable-height modeling table like the pros, for hundreds less.

DIY Pickles: Beets and Grapes 86
Quick and tasty, vinegar pickling is great for preserving a surprising variety of fruits and veggies.

Remaking History 88
A 15th-century English nun wrote the book on recreational fishing technology.

Universal Translator 90
Translate between thousands of language pairs with voice recognition, using the Raspberry Pi.

123 — Board Feet 91
Give your board a lift by adding legs built from off-the-shelf hardware.

The Kit That Launched the Tech Revolution 92
We celebrate the 40th anniversary of the Altair 8800 microcomputer.

Make-an-Entrance Party Doorbell 94
Let your guests choose their own sound effects with wireless sensors and a Raspberry Pi.

Howtoons 95
Launch easy-to-make paper rockets using PVC pipe and an empty soda bottle.

Toy Inventor's Notebook 96
Assemble a kaleidoscope with built-in LEDs to turn any flat surface into a colorful trip.

STATEMENT OF OWNERSHIP, MANAGEMENT AND CIRCULATION

1. Publication Title: Make Magazine; 2. Publication Number: 1556-2336; 3. Filing Date: 10/01/14; 4. Issue Frequency: Bimonthly; 5. Number of Issues Published Annually: 6; 6. Annual Subscription Price: \$34.95; 7. Complete Mailing Address of Known Office of Publication: Maker Media, 1005 Gravenstein Hwy North, Sebastopol CA 95472; 8. Complete Mailing Address of Headquarters: same; 9. Full Names and Complete Mailing Addresses of Publisher, Editor, and Managing Editor: Publisher: Dale Dougherty, Editor: Mark Frauenfelder, Managing Editor: Cindy Lum, all at Maker Media, 1005 Gravenstein Hwy North, Sebastopol CA 95472; 10. Owner: Maker Media, Inc., 1005 Gravenstein Hwy North, Sebastopol CA 95472; 11. Known Bondholders, Mortgagees, and Other Security Holders Owning or Holding 1 Percent or More of Total Amount of Bonds, Mortgages, or Other Securities: Tim O'Reilly, Maker Media, 1005 Gravenstein Hwy North, Sebastopol CA 95472; 12. Tax Status: [x] Has Not Changed During Preceding 12 Months; 13. Publication Title: Make Magazine; 14. Issue Date for Circulation Data Below: Oct. 2013 - Oct/Nov 2014 [Vol 36 - Vol. 41]; 15. Extent and Nature of Circulation, Avg. No. Copies Each Issue During Preceding 12 Months/No. Copies of Single Issue Published Nearest to Filing Date: a. Total Number of Copies [Net Press Run]: 143,895/160,120; b. Paid Circulation [By Mail and Outside the Mail] [1] Mailed Outside-County Paid Subscriptions: 66,555/72,309; [2] Mailed in-county Paid Subscriptions: 0/0; [3] Paid Distribution Outside the Mails: 25,190/22,806; [4] Paid Distribution by other Classes of mail through the USPS: 0/0; c. Total Paid Distribution [Sum of 15 b, [1], [2], [3], and [4]]: 91,745/95,115; d. Free or Nominal Rate Distribution [1] Outside-County Copies: 925/1,069; [2] In-County Copies: 0/0; [3] Mailed at other Classes through the USPS: 0/0; [4] Distribution outside the Mail: 7,954/16,540; e. Total Free or Nominal Rate Distribution [Sum of 15 d, [1], [2], [3], and [4]]: 8,879/17,609; f. Total Distribution [Sum of 15 c and 15 e]: 100,623/112,724; g. Copies Not Distributed: 43,271/47,396; h. Total [Sum of 15 f and g]: 143,895/160,120; i. Percent Paid [15c divided by 15f]: 91.18%/84.38%; 16. Electronic Copy Circulation: a. Paid Electronic Copies: 2,913/3,450; b. Total Paid Print Copies [line 15c] + Paid Electronic Copies [Line 16a]: 94,236/98,565; c. Total Print Distribution [Line 15f] + Paid Electronic Copies [Line 16a]: 103,114/116,174; d. Percent Paid [Both Print + Electronic Copies [16b divided by 16c x 100]]: 91.39%/84.84%; [x] I certify that 50% of all my distributed copies (electronic and print) are legitimate requests or paid copies; 17. Publication of Statement of Ownership: [x] Publication Required. Will be printed in the Dec/Jan '14 issue of this publication. 18. Signature and Title of Editor, Publisher, Business Manager, or Owner [signed] Heather Cochran, Business Manager, 10/01/14. I certify that all information furnished on this form is true and complete. I understand that anyone who furnishes false or misleading information on this form or who omits material or information requested on the form may be subject to criminal sanctions (including fines and imprisonment) and/or civil sanctions (including civil penalties).

Vol. 42, November 2014. *Make*: (ISSN 1556-2336) is published bimonthly by Maker Media, Inc. in the months of January, March, May, July, September, and November. Maker Media is located at 1005 Gravenstein Hwy North, Sebastopol, CA 95472, 877-306-6253. SUBSCRIPTIONS: Send all subscription requests to *Make*, P.O. Box 17046, North Hollywood, CA 91615-9588 or subscribe online at makezine.com/offer or via phone at (866) 289-8847 (U.S. and Canada); all other countries call (818) 487-2037. Subscriptions are available for \$34.95 for 1 year (6 issues) in the United States; in Canada: \$39.95 USD; all other countries: \$49.95 USD. Periodicals Postage Paid at Sebastopol, CA, and at additional mailing offices. POSTMASTER: Send address changes to *Make*, P.O. Box 17046, North Hollywood, CA 91615-9588. Canada Post Publications Mail Agreement Number 41129568. CANADA POSTMASTER: Send address changes to: Maker Media, PO Box 456, Niagara Falls, ON L2E 6V2

92



Eliminate Print Failures

PRINT WITH

voltivo  ExcelFil™
High Grade 3D Printing Filament



2 Spools for only \$77*

CUBICITY.COM/MAKE3D

*Includes Free Shipping. Enter code MAKE3D during checkout.

Limited number of reseller opportunities available
Email sales@cubicity.com for more information



CUBICITY INC. • 844-QBICITY (724-2489) • WWW.CUBICITY.COM

PREPARE FOR BLAST-OFF

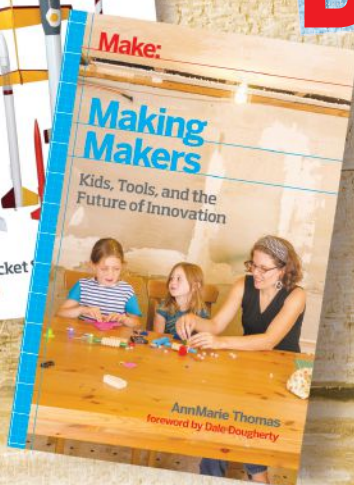

>NEW!

>MAKERSHED.COM

Maker Shed

The official store of **Make:**

Make: Rockets

Learn how to build rockets from the ground up! Starting with the basics of rocket propulsion, readers will learn to make rockets from household objects and then move on to propellant-powered ones.

MAKERSHED.COM/MAKINGROCKETS

Making Makers

Is your child a Maker? How will you maintain their curiosity? This book shares stories and resources to inspire you and the kids in your life to create something amazing.

MAKERSHED.COM/MAKINGMAKERS

Make:®

FOUNDER & CEO
Dale Dougherty
dale@makezine.com

CFO
Todd Sotkiewicz
todd@makezine.com

CREATIVE DIRECTOR
Jason Babler
jbabler@makezine.com

EDITORIAL

EXECUTIVE EDITOR
Mike Senese
msenese@makezine.com

COMMUNITY EDITOR
Caleb Kraft
caleb@makermedia.com

MANAGING EDITOR
Cindy Lum

PROJECTS EDITOR
Keith Hammond
khammond@makezine.com

SENIOR EDITOR
Greta Lorge

TECHNICAL EDITOR
David Scheltema

DIGITAL FABRICATION EDITOR
Anna Kaziunas France

EDITORS
Laura Cochrane
Nathan Hurst

EDITORIAL ASSISTANT
Craig Couden

COPY EDITOR
Laurie Barton

PUBLISHER, BOOKS
Brian Jepsen

EDITOR, BOOKS
Patrick DiJusto

LABS MANAGER
Marty Marfin

CONTRIBUTING EDITORS
William Gurstelle, Nick Normal,
Charles Platt, Matt Richardson

CONTRIBUTING WRITERS
John Abella, Josh Ajima, Chris
Anderson, Andreas Bastian,
Robert Beatty, Phillip Burgess,
Tom Burtonwood, Eric Chu, Dave
Conroy, Michael Curry, Nick
Dragotta, Stuart Deutsch, Matt
Griffin, Gregory Hayes, Kacie
Hultgren, Luis Ibanez, Tom Igoe,
Bob Knetzger, Kelly McVicker,
Forrest M. Mims III, Aaron
Porterfield, Sean Michael Ragan,
Eli Richter, Luis Rodriguez,
Michel Sinner, Yves Sinner, Dan
Spangler, Becky Stern, Matt
Stultz, Anderson Ta, Michael
Weinberg, Chris Yohe

Comments may be sent to:
editor@makezine.com

Visit us online:
makezine.com

DESIGN, PHOTOGRAPHY & VIDEO

ART DIRECTOR
Juliann Brown

DESIGNER
Jim Burke

PHOTO EDITOR
Jeffrey Braverman

PHOTOGRAPHER
Gunther Kirsch

VIDEO PRODUCER
Tyler Winegarner

VIDEOGRAPHER
**Nat Wilson-
Heckathorn**

WEBSITE

MANAGING DIRECTOR
Alice Hill

DIRECTOR OF ONLINE
OPERATIONS
Clair Whitmer

SENIOR WEB DESIGNER
Josh Wright

WEB PRODUCERS
Bill Olson
David Beauchamp

SOFTWARE ENGINEER
Jay Zalowitz

CONTRIBUTING ARTISTS
Matthew Billington, Clint
Blowers, Nate Van Dyke, Erik
Fuller, Brian Kaldorf, Bob
Knetzger, Emmanuel Mota, Rob
Nance, Wes Rowe, Julie West

ONLINE CONTRIBUTORS
Alasdair Allan, Jimmy DiResta,
Agnes Niewiadomski, Haley
Pierson-Cox, Andrew Salomone,
Andrew Terranova

ENGINEERING INTERNS
Enrique DePola, Paloma Fautley,
Sam Freeman, Andrew Katz (jr.),
Pierre-Alexandre Luyt, Brian
Melani, Nick Parks, Sandra
Rodriguez, Sam Scheiner,
Wynter Woods

Follow us on Twitter:
@make @makerfaire
@craft @makershed

On Google+:
google.com/+make

On Facebook:
makemagazine

VICE PRESIDENT
Sherry Huss
sherry@makezine.com

SALES & ADVERTISING

SENIOR SALES
MANAGER
Katie D. Kunde
katie@makezine.com

SALES MANAGERS
Cecily Benzon
cbenzon@makezine.com
Brigitte Kunde
brigitte@makezine.com

CLIENT SERVICES
MANAGERS

Mara Lincoln
Miranda Mota

MARKETING
COORDINATOR
Karlee Vincent

COMMERCE

VICE PRESIDENT OF
COMMERCE
Kelly Peters

DIRECTOR OF
ECOMMERCE
Patrick McCarthy

DIRECTOR OF
COMMERCE DESIGN
Riley Wilkinson

RETAIL CHANNEL
DIRECTOR
Kirk Matsuo

PRODUCT INNOVATION
MANAGER
Michael Castor

ASSOCIATE PRODUCER
Arianna Black

MARKETING

VICE PRESIDENT OF
MARKETING
Vickie Welch
vwelch@makezine.com

MARKETING PROGRAMS
MANAGER
Suzanne Huston

MARKETING SERVICES
COORDINATOR
Johanna Nuding

MARKETING RELATIONS
COORDINATOR
Sarah Slagle

DIRECTOR, RETAIL
MARKETING &
OPERATIONS

**Heather Harmon
Cochran**
heatherh@makezine.com

MAKER FAIRE

PRODUCER
Louise Glasgow

PROGRAM DIRECTOR
Sabrina Merlo

MARKETING & PR
**Bridgette
Vanderlaan**

CUSTOM PROGRAMS

DIRECTOR
Michelle Hlubinka

CUSTOMER SERVICE

CUSTOMER SERVICE
REPRESENTATIVE
Kelly Thornton
cs@readerservices.
makezine.com

CUSTOMER SERVICE
REPRESENTATIVE
Ryan Austin

Manage your account
online, including change
of address:
makezine.com/account
866-289-8847 toll-free
in U.S. and Canada
818-487-2037,
5 a.m.-5 p.m., PST
makezine.com

PUBLISHED BY

MAKER MEDIA, INC.
Dale Dougherty, CEO

Copyright © 2014
Maker Media, Inc.
All rights reserved.
Reproduction without
permission is prohibited.
Printed in the USA by
Schumann Printers, Inc.

CONTRIBUTORS

If you could print anything, real or imagined, possible or impossible, what would it be?



**Michael
Weinberg**

Washington, DC
(Wrongs and Rights)

I would probably print a pet Spinosaurus to ride around town on. It would make it easier to get Congress' attention for important things from the back of a Spinosaurus.



**Andreas
Bastian**

Berkeley, California
(3D Printer
Buyer's Guide)

I would print an object consisting of a single material structured on several length scales to have internal pneumatic computation capabilities and a variety of thermal, mechanical, and optical properties. The object's function is not yet important, but the principles of its construction are.



**Yves and Michel
Sinner**

Colmar (Yves) and
Brouch (Michel),
Luxembourg
(3D Printer
Buyer's Guide)

As a worldwide message against intolerance, we would print the two Buddhas of Bamiyan (in their original size) and get them reinstalled. The Taliban blew up these beautiful, monumentally huge 6th-century Buddha statues in March 2001.



Brian Kaldorf

Pittsburgh,
Pennsylvania
(Photographer,
3D Printer
Buyer's Guide)

I would print a really good cheeseburger. Once that becomes a reality, there's nowhere to go but down.



Kelly McVicker

San Francisco,
California
(DIY Pickles: Beets
and Grapes)

If I could 3D print anything, I would print myself up a real-life Falcor (the Luck Dragon from *The NeverEnding Story*), so I could fly around on his scaly, furry back.

PLEASE NOTE: Technology, the laws, and limitations imposed by manufacturers and content owners are constantly changing. Thus, some of the projects described may not work, may be inconsistent with current laws or user agreements, or may damage or adversely affect some equipment. Your safety is your own responsibility, including proper use of equipment and safety gear, and determining whether you have adequate skill and experience. Power tools, electricity, and other resources used for these projects are dangerous, unless used properly and with adequate precautions, including safety gear. Some illustrative photos do not depict safety precautions or equipment, in order to show the project steps more clearly. These projects are not intended for use by children. Use of the instructions and suggestions in *Make:* is at your own risk. Maker Media, Inc., disclaims all responsibility for any resulting damage, injury, or expense. It is your responsibility to make sure that your activities comply with applicable laws, including copyright.





coming soon !



Large Build Volume
10"x 8"x8"



Fully Automated
Platform Leveling



Faster Printing with
Higher Precision



Enclosed Printing
Environment with New
Proprietary Print Surface



Quiet Operation with
Integrated Air Filtration



ABS | PLA Printing with
Smart Support Generation



Powerful, Easy to
Use Software



UPBOX

UP QUALITY | LARGE FORMAT

GO BIG, GO BOX



A 3D World Cup

What if 3D printers competed like soccer teams?

WHAT IF THERE WERE A WORLD CUP FOR 3D PRINTING? THIS IDEA MUST

have started incubating on my trip to Germany for Maker Faire Hannover, which took place during the World Cup. After a Saturday walking the Faire, I went to the hotel bar at night to watch Belgium lose to Argentina. The Netherlands beat Costa Rica in a shootout. After the last match, I began to leave when two brothers introduced themselves to me — Michel and Yves Sinner from Luxembourg. Michel and Yves run 3Dprintingforbeginners.com and they came to Hannover after visiting Maker Faire Paris. As we talked, I mentioned that we were preparing for *Make*: magazine's annual review of 3D printers. Our own "shootout" would be held this year at America Makes, a public-private partnership around additive manufacturing located in Youngstown, Ohio. Yves told me that, as an innovation advisor for Goodyear, he had visited Akron many times, and he knew exactly where Youngstown was. Small world. I invited both of them to join us and they enthusiastically accepted.

America Makes renovated a storefront (once known as Furnitureland) in downtown Youngstown, a city that, like many in the Midwest, is struggling to rebound from the loss of its manufacturing base. Made of brick and timber beams, the facility covers three floors and includes many industrial 3D printers. Our editorial lead, Anna Kazianus France, had made the arrangements for 22 different consumer 3D printers (we ultimately tested 26) to be set up in the basement, and she prepped our team of 17 testers — 15 Americans, along with Michel and Yves. Seeing the array of 3D printers, Michel said to me: "This is 3D printer heaven." Our weekend event began with a welcome from Ralph Resnick, founding director of America Makes, and other representatives from Youngstown who were excited that this event was taking place there. Youngstown was Rio for 3D printing.

If there were a 3D World Cup, the U.S. would have enough "teams" to form its own

domestic league. Representing California are Deezmaker in Pasadena, Airwolf in Costa Mesa, Printrbot in Lincoln, and Type A in San Francisco. Colorado has LulzBot. South Carolina has 3D Systems. Goshen, Indiana, is an unlikely place for a 3D printing company, but that's where SeeMeCNC builds the Orion Delta 3D printer. An MIT spinoff, Formlabs, represents Boston, and MakerGear is Cleveland's entry. Market leader MakerBot represents a resurgent Brooklyn and the return of manufacturing in New York City. The U.S. league for 3D printers is very competitive. Dremel's entry into 3D printing, which we preview in this issue, could be a game changer.

Yet what makes a 3D World Cup possible is the increasing number of international entrants. The look-at-me design of the BeeTheFirst from BeeVeryCreative would make Portugal a crowd favorite. Germany would enter its orange and green Fabbster,

which I saw at Maker Faire Hannover. Italy has XFAB from DWSLAB. Canada would send the snow-white Ditto Pro from Vancouver. We would look at Zortrax's capable M200 from Poland and the DeeGreen from be3D in the Czech Republic. Europe's strongest country is probably the Netherlands, which leads with a favorite of the testers, Ultimaker. It also has Leapfrog and Felix. There are lesser-known companies in Sweden (ZWYZ Printer), Spain (Witbox from bq), France (SpiderBot) and the U.K. (Robox). (We weren't able to test all of these models.) I could imagine a quarterfinal with Poland playing Portugal.

In Asia, the field is less clear. China is producing a growing number of 3D printers, including FlashForge, which the Dremel printer is derived from. The UP printer, which is relabeled as Afinia for the American market, is capable and low-cost. A new printer we tested, the inexpensive da Vinci printer from XYZprinting, could represent Taiwan and China, but it wasn't a leader in print quality. There are some clones like Mbot that are inferior in design and performance, but China is not the only country making clones. None of China's printers may be a favorite this year, but watch out for them in the future.

The comparison to the World Cup breaks down when we consider South America. There is little evidence of 3D printers coming from countries like Brazil or Argentina, though this could be due to our own failure to find them.

Nonetheless, judging by the printers we had in the basement of America Makes, we would have enough countries for a round of 16 global competitors. We could have a da Vinci v. Ultimaker semi-final. I might have predicted that MakerBot would get to the finals, but like Brazil, they fell short; the two most competitive printers, the ones ending up in the final match would be from the U.S. and the Netherlands: LulzBot TAZ 4 v. Ultimaker 2. 🏆

BY DALE DOUGHERTY,
founder and CEO of Maker Media.



PATENT YOUR FUTURE

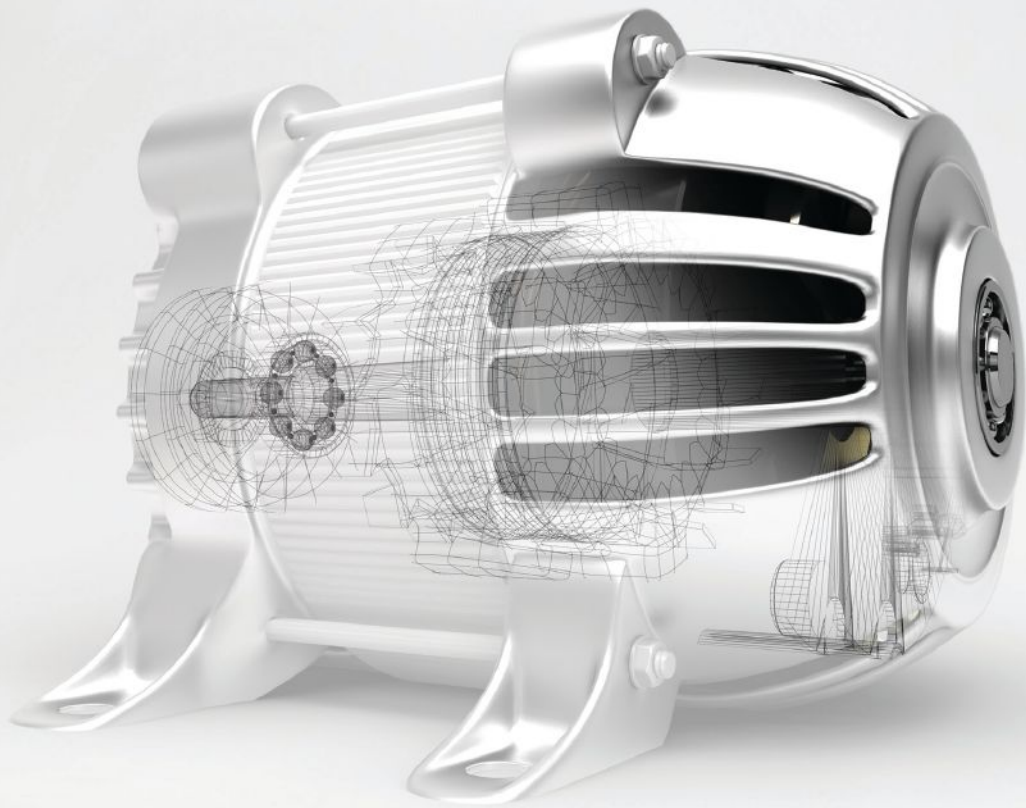

Earn tech respect with a Digital Maker and Fabrication Bachelor of Science degree

Digital fabrication is about to revolutionize how we invent and create. Learn to lead this revolution while developing your own inventions in an unprecedented university-wide, open lab environment. As part of their curriculum, graduates of this program will file for their own U.S. patent. This unprecedented degree is the first of its kind being offered from the elite private university that first focused at the dawn of the computer revolution on advancing computer technology.

Be the first to join a long line of trail blazing graduates that will lead the next transformation of technology and industry.



TECH
RESPECT



Patent your future. Invent something that
changes everything!
Learn more today at www.uat.edu/DMF

Volumes of Inspiration

» I've taken things apart (successfully) and put them together (not always successfully) for as long as I can remember. I found my first issue of *Make:* magazine six or seven years ago and you guys are one of the few magazines I've kept a subscription for.

I don't always pass out in a pile of glossy magazines. But when I do, you can be sure it's *Make:* magazine.

Thanks for keeping it going.

— Seth Melville,
Colorado



» I read your magazine frequently, and I don't feel like I would've had the inspiration to see [my Dream Machine] project through without past articles such as the Forrest Mims Amateur Scientist series, and earlier articles all the way up to this publication. Thank you for producing a high-quality magazine that also teaches as much as it generates a community eager to learn and apply ideas. We need more folks thinking critically out there.

Thanks for being a spark in the dark.

— Jay Parry, via web

» Hi Jason [Babler, *Make:* creative director]! I'm almost halfway done with the clay T. rex. It's

looking pretty good actually. The [Maker Faire Bay Area blue] ribbon you gave us is awesome. We put all the ribbons on display, but yours is my favorite! Make on!

— Carson, Arizona

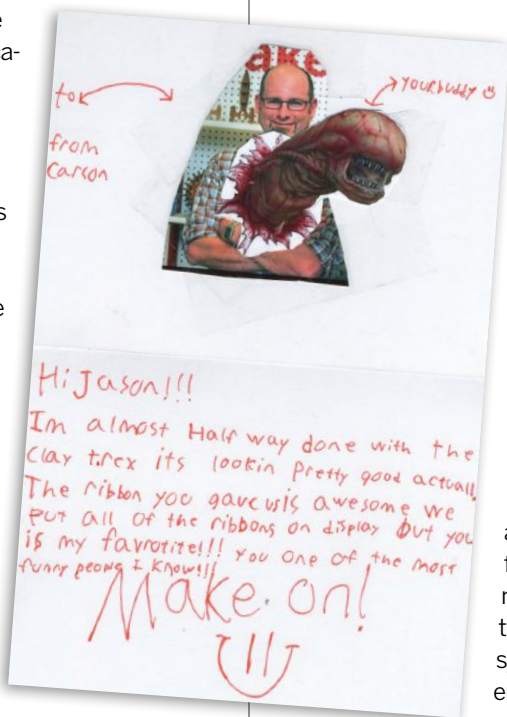

IN RESPONSE
TO VOLUME 40'S
"WHERE ARE
THE WOMEN IN
MAKERSPACES?"

» There are more women in technology than there used to be, but there's still a gap. I'm a sysadmin and have been in the IT field for nearly 20 years. Years ago, there were two female programmers, and I was the only female sysadmin in the entire company.

Being a girl and also having a "cute" Southern accent, I had to work extra hard to prove myself, and I did. I finally earned respect from the guys. Why is there a stereotype that girls aren't good at math or science? I'm a math whiz and I can thank my super-genius mom helping me with homework for that. If she had the opportunity, she could've been an electrical engineer.

Doesn't matter if you're a boy or a girl, don't let anyone discourage you and tell you that you can't do something. With hard work and determination, you can do anything you set your mind to.

— Susan McRorie, Monroe, NC

"CNC Makerspace Shed" Update

■ Since its publication in Volume 40, the "CNC Makerspace Shed" has gathered a lot of attention. For those who don't have access to a CNC machine, we've added instructions for hand cutting the trusses. Visit makezine.com/projects/cnc-makerspace-shed to get all the details.



Share the gift of
Make:
this holiday season!

**BOTH YOU
AND YOUR GIFT
RECIPIENT WILL
RECEIVE SIX
ISSUES CHOCK
FULL OF:**

- Fun and creative projects for all skill levels
- Highlights on gadgets and gear for makers
- Features on innovative makers
- How-to guides and resources

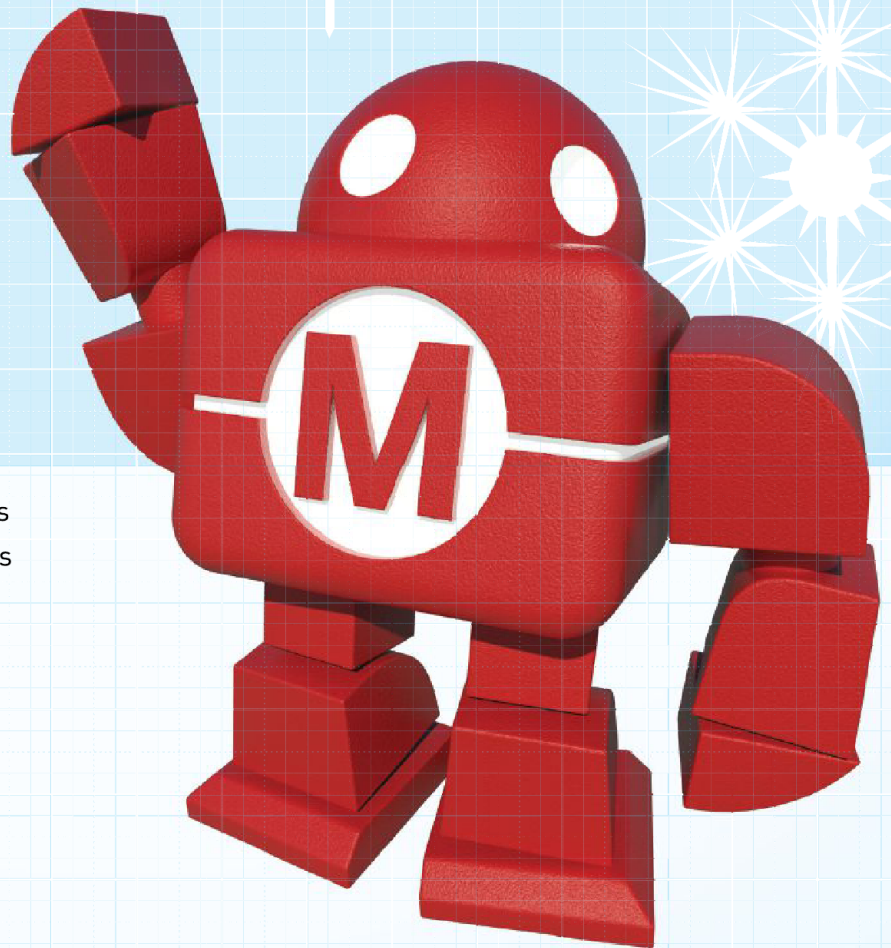

Make:

Subscribe today! makezine.com/bogo

SHARE THE GIFT OF MAKE: + SUBSCRIBE OR RENEW. JUST \$34.95 FOR 2 SUBSCRIPTIONS: 6 ISSUES / YEAR.
OFFER EXPIRES DECEMBER 31, 2014

Punks and Makers

How a music revolution powered the Maker Movement.

Written by Chris Anderson ■ Illustrated by Matthew Billington

LAST YEAR AT SOUTH BY SOUTHWEST, FORMER NIRVANA DRUMMER Dave Grohl gave a speech about his beginnings that should resonate with any maker:

As much as I wanted to be in a band, I was there, alone in my bedroom, day in day out with my records and my guitar, playing with myself for hours. I would set up pillows in the formation of a drum set on my bed and play along to records until there was literally sweat dripping down the Rush posters on my walls. Eventually I figured out how to be a one-man band. I took my crappy old handheld tape recorder, hit record and laid down a guitar track. I would then take that cassette, place it in the home stereo, take another cassette, place THAT into the handheld recorder, hit play on the stereo, record on the handheld, and play drums along to the sound of my guitar. Voila! Multi-tracking! At 12 years old!

This was the experience of an entire generation, the indie/punk scene of the early '80s. And in that underground music revolution you can see the roots of today's Maker Movement. What Grohl and his contemporaries were doing was democratizing the tools of production in a way that is now echoed in everything from desktop manufacturing to crowdfunding.

I learned this firsthand as a teenager in Washington, D.C., in the early 1980s, when it was one of the hot spots of the American punk rock movement. Bands such as Minor Threat and the Teen Idles were being formed by suburban kids and playing in church basements. Despite not knowing how to play an instrument and having limited talent, I got caught up in the excitement of the moment and played in some of the lesser bands in the scene. It didn't lead to music stardom, but it did

instill a DIY spirit that largely informed the rest of my career.

What was new about the 1980s punk phenomenon was that the bands did more than just play; they also started to publish. Photocopiers were becoming common (Kinko's copy shops went national in the early '80s), and from them started a "zine" culture of DIY magazines that were



distributed at stores, shows, and by mail. Cheap four-track tape recorders such as the TEAC Portastudio (\$1,200 when it was introduced in 1981) hit that market, allowing bands to record and mix their own music without a professional studio. And a growing industry of small vinyl pressing plants let them make small-batch singles and EPs, which they sold via mail order and

local shops.

This was the start of the DIY music industry. The tools of the major labels — recording, manufacturing, and marketing music — were now in the hands of individuals. Eventually, some of these bands, led by Minor Threat and then Fugazi, started their own indie label, Dischord Records, which produced hundred of albums and is still running today. They didn't need to compromise their music to get published and they didn't need to sell in big numbers or get radio play. They could find their own fans; indeed, the fans found them via word-of-mouth, and postcards poured into micro-labels to order music that couldn't be found in most stores. The relative obscurity conferred authenticity and contributed to the rise to the global underground that defines web culture today.

My bands did all of this, from the photocopied fliers to the zines to the four-track tapes to the indie-label albums. We never got very big, but that wasn't the point. We still had day jobs, but we were doing what we thought was genuinely innovative and getting people at our shows.

Where the DIY punk movement co-opted the means of production, in the web age people used desktop publishing, then websites, then blogs, and now social media. Indie-pressed vinyl became YouTube music videos. Four-track tape records became Pro Tools and iPad music apps. Garage bands became Apple's GarageBand.

Yesterday's garage bands are today's garage hardware startups and Kickstarter is the new indie launch pad. Punk's not dead — it's just traded electric guitars for soldering irons. 

CHRIS ANDERSON is the founder of drone company 3D Robotics, author of *Makers: The New Industrial Revolution*, and former editor-in-chief of *Wired*.

The people-and-solar-powered ELF

Driving better health and a healthier planet



"We used the ShopBot at a TechShop in the prototype stage, and now use our own ShopBot to cut several flat panels for the ELF, to cut inexpensive molds, and to make quick models of new products. We continue to work with ShopBot; they're really good at helping people improve on various steps in the manufacturing process."

Rob Cotter, Founder and CEO, Organic Transit



Organic Transit is on a mission to help people get around without hurting the planet. Their first product, the ELF, is a solar-and-pedal driven hybrid trike that gets the equivalent of 1800 MPG. Each ELF is hand built and legally a bicycle, so it can travel on bike paths, park on sidewalks and requires no gas, license, registration or insurance. You can travel up to 20 mph on electric power only and up to 30 mph combined with pedaling. And it can handle an amazing 350 lb. payload!

This innovative company has been collaborating since the beginnings of the ELF "project" with another forward-thinking North Carolina company, ShopBot Tools.

Ted Hall, ShopBot's Founder and CEO, is excited to be involved. "Our mantra is to make digital fabrication technology readily accessible and usable. We make affordable tools that empower starting and growing a business. We love to see the tools put to work in innovative ways, and helping create new jobs."

Who: Organic Transit

Site: www.organictransit.com

Where: Durham, NC

Tool: ShopBot 96 X 48
CNC router

What project are **you** trying to get off the ground (or drive down the street)? Give ShopBot a call. We'll help you choose the right tool for the job.

We make
the tools
for making the
future.

ShopBot[®]

888-680-4466 • ShopBotTools.com

Wrongs and Rights

Written By Michael Weinberg

In the world of 3D printing, copyright may not mean what you think it does.

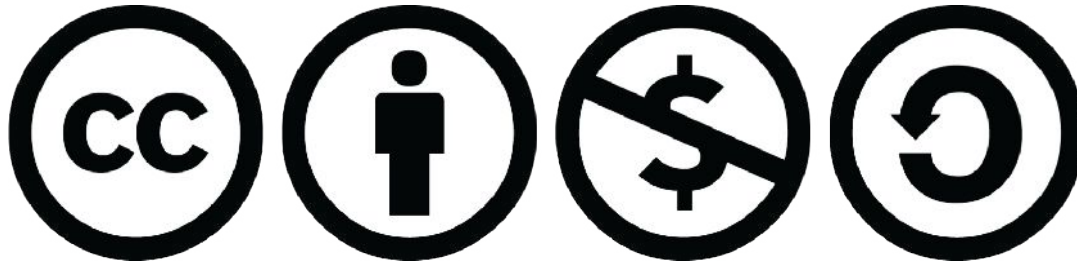

MICHAEL WEINBERG is vice president of Public Knowledge, a nonprofit advocacy group that represents consumers in technology policy issues in Washington, DC. @MWeinbergPK

3D PRINTING IS ABOUT TO TURN MOST OF WHAT YOU THINK YOU KNOW ABOUT INTELLECTUAL PROPERTY LAW ON ITS HEAD.

Although physical objects can be protected by copyright, patent, or trademark, that protection is not always the same as the protection of digital goods like photographs or computer code. Among other things, this can lead to confusion about open-source licensing, and the differences between copyrights and patents.

Copyright is a type of intellectual property right that automatically protects creative works, such as paintings, poems, and sculptures. Software is also protected by copyright, essentially because it is treated like a novel or poem. The moment you create a work in the “copyright” category, it’s protected — you don’t need to register your copyright in order to get protection. As a result, we are all owners of probably hundreds of thousands of copyrights, whether we want them or not.

One of copyright’s limitations is that it only protects creative objects. Functional objects — things that do things — are instead protectable by patent. While patent differs from copyright in many ways, one of the most important is that it is not automatic. You need to apply for a patent, something that requires a significant amount of time and money. Every software program or mural comes with an automatic copyright just waiting to be licensed, but the act of creating a working engine gives you nothing.

Once you create an object protected by copyright or patent, you can impose all sorts of conditions on how it is used — that’s what a license does. Various open-source software and Creative Commons licenses

take automatic copyright protection and use it to encourage openness by making that openness a condition of use. Those conditions are backed up by a legal right — if you use a protected work without complying with the conditions, you may be infringing on its copyright.

In the world of 3D printing it is critical to remember that you are often working with two separate elements — the object and the file. While a digital photograph and a file for a digital photograph are essentially the same thing, intellectual property law may treat the object and the file that represents the object completely differently.

A purely functional object, like a screw, falls firmly into the “patent” camp and cannot be protected by copyright. However, for the sake of this article, let’s say the screw’s digital file falls under copyright. That file is posted on Thingiverse with a Creative Commons Attribution-NonCommercial-ShareAlike 3.0 license. What does the license mean?

Firstly, many people would not consider it an open-source license, because it violates the open-source hardware and software “No Discrimination Against Fields of Endeavor” provision. Secondly, it probably only applies to the file, not to the object created from the file. That means copying the digital file without adhering to the terms (attribution, share alike, or whatever) is copyright infringement. However, the Creative Commons license does not protect the physical functional object represented in the file — the screw itself. That means that, assuming it is done without copying the digital file, anyone is free to copy the screw without worrying about the license terms.

It is probably safe to say that this lack of protection for the physical manifestations of their digital files would come as a surprise to many people uploading files of functional objects to file-sharing websites.

In addition, at least one court has found that, unlike photographs, 3D scans of objects are not protected by copyright. That does not mean that scans cannot infringe on a copyright. But it does mean that the scanner does not have a new copyright in the scan.

To understand how this works, imagine a sculpture created by Alice. Since the sculpture is a nonfunctional, creative work, Alice has a copyright in the sculpture. Bob comes along and scans the sculpture. Bob has created a copy of the sculpture, and if he failed to get permission from Alice, he is probably infringing on her copyright. However, Bob does not have new copyright on his scan. If Charles comes along and copies Bob’s scan file without permission, he has not infringed on Bob’s copyright because no such copyright exists.

This illustrates the importance of keeping track of exactly what you are talking about in the world of physical infringements. Are you talking about the thing or just a digital representation of a thing?

Twenty-plus years of open licensing has trained many of us to think of openness in terms of copyright. In order to transition that training into the world of 3D printing, we need a fairly nuanced understanding of where copyright is — and is not — in play. That will be hard. However tempting it may be, assuming latent copyrights where none exist will not make that process any easier. 🚫



ENGRAVE IT. CUT IT. MARK IT.

Laser cut even the most elaborate designs with ease.

Whether you're working with wood, acrylic, paperboard or just about anything else, Epilog Laser systems precisely cut the components you need.

Your vision combined with Epilog's power equals spectacular creations.



**Assembly Required*

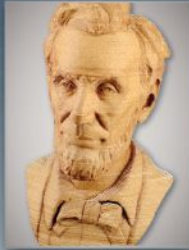

Desktop Systems Starting at \$7,995

Contact Epilog Laser today for a laser system demo!

epiloglaser.com/make • sales@epiloglaser.com • 888-437-4564

MADE IN USA
Golden, Colorado

DREAM. CREATR. EXCEED.

Leapfrog brings ideas to life. Fast. Our **Creatr**, **Creatr XL**, **Creatr HS** and **Xeed** printers were designed to bring fascination and function together by giving you the ability to create everything from practical, 3D solutions for every day needs, to objects limited only by your imagination. Best-in-class pricing, strength, versatility, and unstoppable European manufacturing make our printers the entrepreneur's dream and the dreamer's reality.

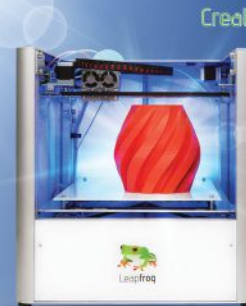

MADE ON EARTH

The world of backyard technology

Know a project that would be perfect for Made on Earth?
Email us: editor@makezine.com



HARPOON GUN

Starting with the 3D models from the game, I converted the designs into watertight STL files I could feed to my Carviewright CNC machines. The machines do 90% of the work, but I still had to smooth the parts and prep them for molding. Each of the parts was molded using silicone rubber, then cast in semi-rigid urethane resin that would flex on impact instead of shattering. After assembly and cleanup, all it needed was a masterful paint job to turn a piece of plastic into a believable, formidable monster-hunting weapon.



LIGHTNING GUN

After the Harpoon Gun, the Lightning Gun is the one I'd most like to hang on my own wall. Since there were a lot of parts that were repeated multiple times over, the prototyping and moldmaking went pretty quickly. Casting took a bit more time, but once the whole thing was assembled it was no time at all before the whole thing was ready for paint.



FORGING VIDEO GAME PROPS

PROTAGONIST4HIRE.BLOGSPOT.COM

It all started with a phone call from a buddy over at 2K Games. “Do you know anyone who can build four real-world props from an upcoming sci-fi video game?” he asked. I quickly replied, “Yup, I know the perfect guy: Shawn Thorsson.”

Thorsson graced the Volume 32 cover of *Make:* magazine with his costumes and props, so he was the perfect maker to partner with. Still, building four life-size props in less than a month nearly killed him, but the results are impressive.

In the video game “*Evolve*,” you play as a futuristic hunter battling huge monsters — or you can play as the beast. Based on the arsenal Thorsson built, it doesn’t look like the behemoths will stand a chance. Below, he talks about how he built each one.

—Jason Babler



LASER CUTTER

Deceptively simple at first glance, this proved to be the most difficult piece to make. All told, there were 54 separate components that had to be CNCed, 3D printed, molded, cast, prepped, painted, and assembled to get the final result.

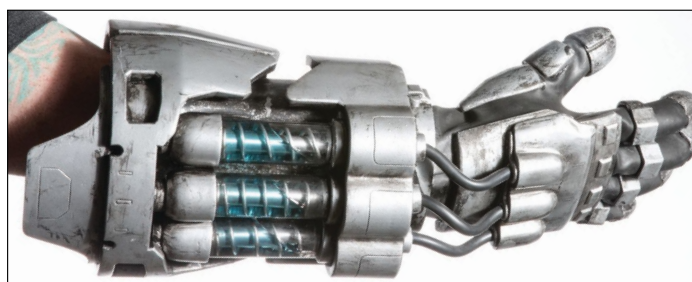

LAZARUS DEVICE

This one uses 3D-printed shells bonded to a rotocast resin foundation piece and a heavy-duty electrical safety glove. For the tubes on the backside, I started with some springs and rods made of aluminum stock, fitted them into some clear acrylic tubes, and then filled the tubes with distilled water and food coloring before sealing them shut.

Jeffrey Braverman & Gunther Kirsch

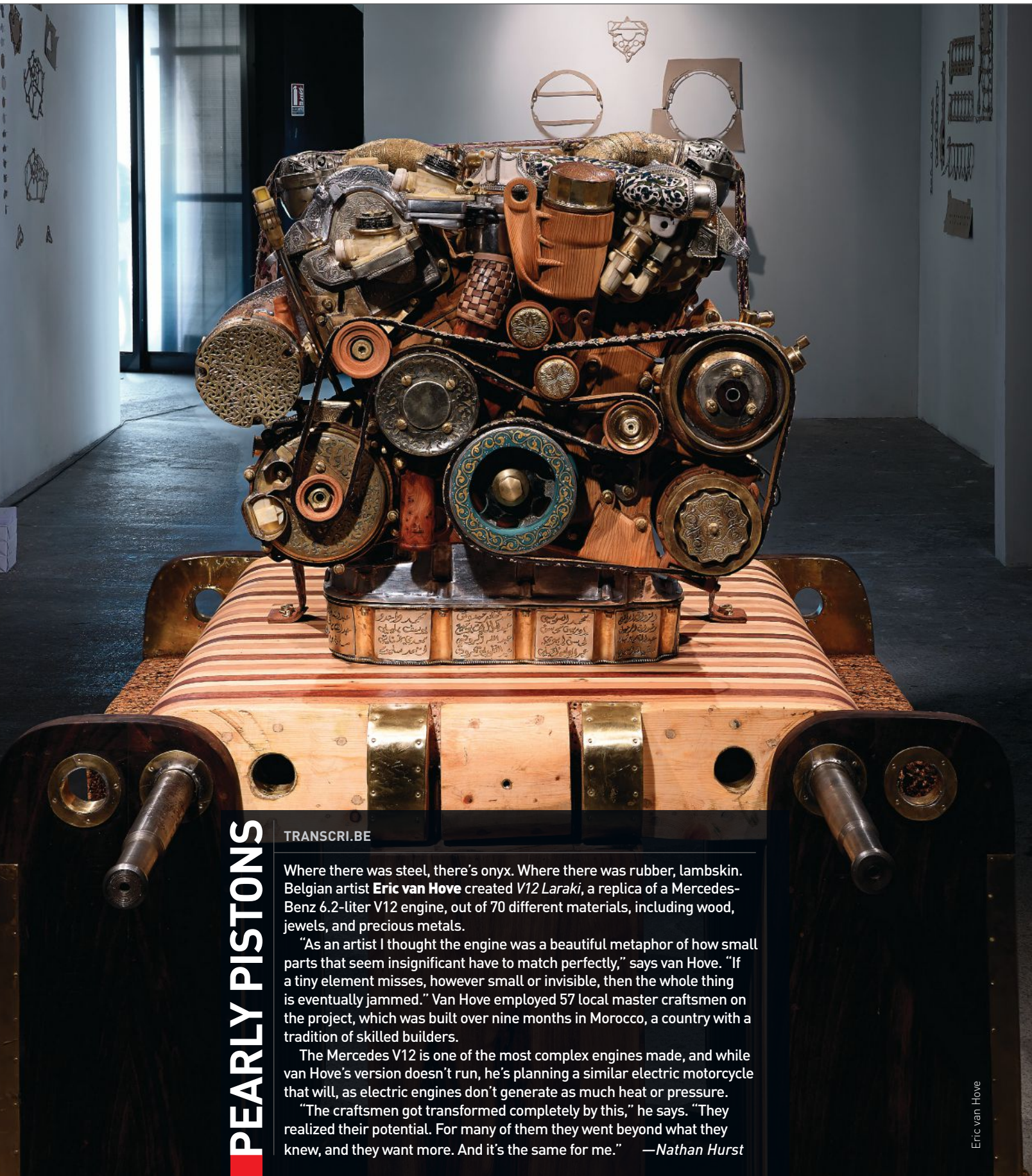

PEARLY PISTONS

TRANSCRIBE

Where there was steel, there's onyx. Where there was rubber, lambskin. Belgian artist **Eric van Hove** created *V12 Laraki*, a replica of a Mercedes-Benz 6.2-liter V12 engine, out of 70 different materials, including wood, jewels, and precious metals.

"As an artist I thought the engine was a beautiful metaphor of how small parts that seem insignificant have to match perfectly," says van Hove. "If a tiny element misses, however small or invisible, then the whole thing is eventually jammed." Van Hove employed 57 local master craftsmen on the project, which was built over nine months in Morocco, a country with a tradition of skilled builders.

The Mercedes V12 is one of the most complex engines made, and while van Hove's version doesn't run, he's planning a similar electric motorcycle that will, as electric engines don't generate as much heat or pressure.

"The craftsmen got transformed completely by this," he says. "They realized their potential. For many of them they went beyond what they knew, and they want more. And it's the same for me." —Nathan Hurst

Eric van Hove

A LIGHT PAPER CUT

THEBLACKBOOKGALLERY.COM/ARTISTS/HARI-DEEPTI

When **Harikrishnan Panicker** and **Deepti Nair** moved from their native India to their current home of Denver, Colorado, the husband-and-wife team started hosting screen-printing workshops as a way to meet people.

As Hari & Deepti, they began showing resulting collaborations, which evolved into today's cut-paper wonderlands. "The initial boxes were not lit, but were hand-painted watercolor dioramas," explains Hari. "In India we had seen shadow puppetry, the Balinese art form. We tried it, and immediately knew it would be incredible."

The couple works on each scene together. "We are extremely inspired by nature, and are always looking at things with that aspect — whether it could work as a light box. We start with an idea, think, sit and sketch it out together, transfer all the layers to a piece of vellum, and then split the cutting up."

Their pieces have ranged from five inches by seven inches to six feet square. The largest took them about a month from planning to installation.

—*Gregory Hayes*



Harikrishnan Panicker and Deepti Nair



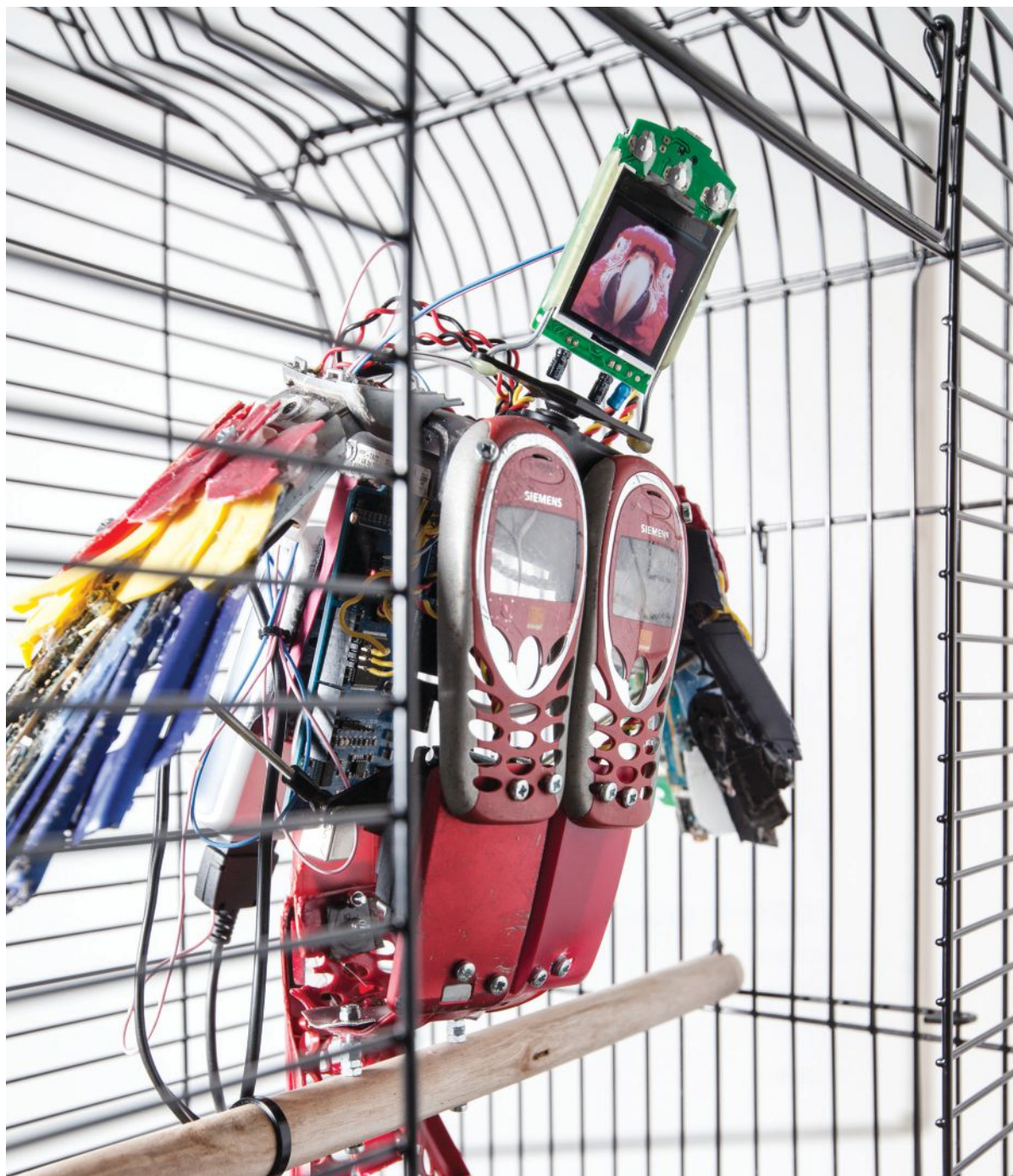

Neil Mendoza

BIRD CALLS NEILMENDOZA.COM/

Cellphones are frequently seen as stress-inducing devices, allowing our obligations to follow us wherever we go. Yet collaborating artists **Neil Mendoza** and **Anthony Goh** used broken and discarded cell phones to create a sculpture that is both peaceful and beautiful. *Escape III* is a kinetic, interactive installation of high-tech birds perched in a tree.

Each Arduino-equipped bird connects via Ethernet to a central Raspberry Pi, which coordinates the movements,

sounds, and lights of the birds. Not only do the birds call to each other, but viewers of the piece can also call the birds on a nearby 1940s-style rotary phone.

According to Neil, the installation “creates an alternate reality in which these unwanted phones and noises become something beautiful.” This piece certainly succeeds in that endeavor.

— *Matt Richardson*

AMBIENT LIGHTNING

TEMPESCOPE.COM

Ken Kawamoto got the idea for his ambient weather display, the Tempescope, while studying to become a meteorologist in his spare time: "I thought that if I could recreate the formation of clouds and rain on my desktop it would help me understand the weather more, as well as being extremely cool."

Built with an ATmega328P microprocessor, water pump, and a mist diffuser, the Tempescope simulates clear skies, cloud cover, and rain. An RGB LED provides daylight and even lightning when the forecast calls for it. A remote controller connected to a PC via USB wirelessly transmits weather data to the device, and since data is pulled from the internet, it can re-create weather happening anywhere in the world, not just in your backyard.

So even if it's balmy outside, you can still curl up on the couch with a good book during a gentle rain.

—Craig Couden



Ken Kawamoto





DISNEY'S NEW ANIMATED CRIME FIGHTERS ARE ARMED WITH INGENUITY AND HIGH-TECH TOOLS.

HEROES IN THE MAKING

Written by Nathan Hurst

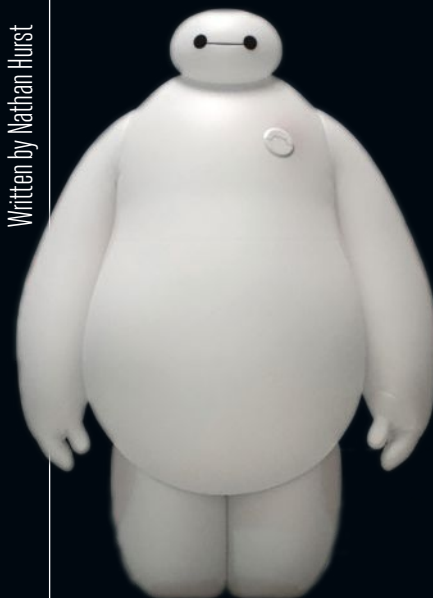

Walt Disney was a maker. Disney movies inhabit a world of fantasy and magic, but the man

behind the mouse was also a roboticist and a futurist who built theme parks and automatons.

So it's fitting that the latest Disney hero is a maker and roboticist, too. Culled from the pages of a Marvel comic, Hiro Hamada, the teen at the center of Disney Animation's *Big Hero 6*, is a prototypical boy genius. His closest companion: an inflatable robot named Baymax.

Robotics has been done before, including by Disney. But *Big Hero 6* is tackling it a different way — with 3D printers and scanners, nanobots, makerspaces, and soft robotics. In bringing maker tech to the big screen, Disney is saying a maker can be a superhero.

Hiro's efforts to uncover a criminal plot lead to the formation of a superhero team propelled, not by radioactive accidents, but by their own ingenuity as they battle a masked figure who commands a swarm of micro drones. Disney Animation's last two movies, *Frozen* and *Wreck-It Ralph*, were fairy-tale fantasy and '80s nostalgia, but *Big Hero 6* is celebrating the maker, and not by accident.

"We're all big fans of the world of makers. A lot of us are hobbyists, 3D printers, and 3D machinists, and in our spare time we build lots of odds and ends," says Disney Animation chief technology officer Andy Hendrickson, a diver who mills his own SCUBA parts. "We've been watching the 3D printing spot, and the Internet of Things, for years now. Besides personal fascination, we've always tried to find a way to take what's hip in the world and put it in our movies."

ROOTED IN REALITY

As with much of what Disney does, the maker tools in the story are re-envisioned with a sort of Disney panache, based in reality but moving slightly beyond it, an example of what could be coming next. Hiro himself assembles a nanobot swarm, like an advanced version of the shape-building Kilobots designed this year at Harvard. The 3D printers he uses in a school makerspace have multiple extruder arms, and print

(much) faster than current printers, using better materials. Over the city float inflatable wind turbines, sending power down through their tethers.

"We knew that we wanted the movie to be slightly futuristic, but grounded in reality. So we were looking at a lot of bleeding edge technology," says co-director Don Hall. "We were trying to look ahead at the next five to 10 years and think, where is technology going? And try to make assumptions. And it looked like 3D printing, to me, was magic."

And then there's Baymax, who first appears as a nurse robot for Hiro who, like a typical teenager, doesn't feel much need to be nannied. When Hiro has to fight a supervillain, Baymax requires some modifications, including 3D-printed armor and rocket boots. "So it was really important for Hiro to have the intellect, and also the tools, to be able to have Baymax go through that transformation," says co-director Chris Williams. "It's absolutely fundamental to the story that Hiro was a maker."

The ensuing adventures draw directly from research on core soft robotics ideas, including durability and (self) repair, and could even inform future robotics work — the crunchy-on-the-outside exoskeleton, for example.

While exploring ideas for the technology and scenery, Hall and Williams traveled extensively, visiting NASA's Jet Propulsion Lab, TechShop, and Disney Imagineering, as well as robotics labs at MIT, Harvard, Tokyo University, and more. (The movie's setting, San Fransokyo, is part Tokyo, part San Francisco.) At Carnegie Mellon, they met Chris Atkeson, a robotics professor, and toured his lab.

"I knew the challenge was going to be to put a robot on screen that we've never seen before. It had to be appealing, and huggable, and all things good," says Hall. "When I saw what Chris was working on, this vinyl, inflatable robot, I knew right then and there that that was going to be our Baymax. So Baymax's personality, and entire being, actually came out of that fateful research trip to Carnegie Mellon."

Atkeson showed the directors a video of a soft robot from iRobot expanding out of a smaller, portable case — not unlike what



"WE WERE TRYING TO LOOK AHEAD AT THE NEXT 5 TO 10 YEARS AND THINK, WHERE IS TECHNOLOGY GOING? AND IT LOOKED LIKE 3D PRINTING, TO ME, WAS MAGIC."

**“COULD YOU BUILD YOUR OWN
REPLACEMENT TO FILL A
HOLE IN YOUR HEART?”**



Baymax does, and asked, “Why don’t you make the robot inflatable?”

“If you’re going to have robots essentially interacting with people, they need to be soft and safe, and our vision of that is inflatable robots,” Atkeson told them. Not only are inflatables cheaper than metal robots, they’re light and safe and appropriate for personal care. To take care of people, robots will have to touch them, he explains. “You’ll have to dress [people], you have to comb their hair, you’ve got to brush their teeth. You’re not going to do that with a bulldozer. It’s just too dangerous.”

BETA BAYMAX

Hiro’s story began back in the ’90s, before “maker” was a common term, and Baymax was more of a bodyguard than a nurse. Two Marvel writers, Steven Seagle and Duncan Rouleau, assembled a team of characters based partly on Japanese pop culture tropes — boy genius, a boy and his robot — for a comic called *Alpha Flight*. The duo never expected the team to exist past a single comic. This was before anime, manga, and their ilk were well known in the U.S., and it led Seagle and Rouleau to address the relationship between humans and robots, a question that seems even more prescient today. The pair gave the characters robust bios and backstories, and that’s partly what Disney latched on to.

In the movie, Hiro inherits Baymax from his brother — a slight diversion from the comic book story — and the pair are more like brothers than an engineer and his robot. “If you’re a genius, could you build your own replacement to fill a hole in your heart, a hole in your house, a hole in your family?” asks Seagle. “Robotics kind of came as a way to make that somatic concern come to life in the comic.”

Seagle and Rouleau still work together, as part of a multimedia production studio called Man of Action. As with *Big Hero 6*, when they speak about their best-known work, the Cartoon Network show *Ben 10*, Seagle and Rouleau focus on their love for the characters and their stories. The cast includes more than just Hiro and Baymax, and in Disney’s interpretation, they’re all makers, with one exception, who joined the team late.

Big Hero 6 popped up again in 2008,

this time as a comic written by Chris Claremont, a Marvel rock star whose work appeared in the *X-Men* movies. While the five-issue series doesn’t devote much time to backstory, Claremont introduced an additional character, Fred — aka Fredzilla — who harbored an enormous, mysterious power. “It was a chance to play with some new characters who hadn’t been around for a generation or two, and see what kind of fun I could have with them and they could have with me,” says Claremont, of writing the series. “The nice thing about *Big Hero 6* is that it always was a cool and different take on what many people consider the standard model trope.”

In Disney’s retelling, Fred is instead a loveable fanboy, equipped with a super suit, thanks to Hiro. The others are geeks like Hiro, experimenting with lasers (Wasabi), chemistry (Honey Lemon), and magnetic levitation (Go Go Tomago).

For those last two, co-director Hall recalls finding inspiration in an all-girl robotics team from Pittsburgh. “I was really impressed with the spirit of these girls, and the idea that they had been on other robotics teams of the past but were always sort of delegated to be the videographers, that sort of thing,” he says. “So they formed their own group, called the Girls of Steel ... their spirit really kind of infused some of the early thoughts on our characters, like Go Go and Honey Lemon.”

“I think we’re inspired by people who ... have the guts to try to tackle some of this stuff on [their] own,” Hall goes on. “I love the fact that this movie could celebrate that, celebrate science, and I guess nerd culture, and might help kind of inspire more kids to get into science.” To that end, Disney also collaborated with XPRIZE for a challenge related to the movie: Six kids who send videos of their approach to solving a world problem will win trips to the *Big Hero 6* premiere.

“We allow ourselves to dream about what the future could be, and we have the ability to make a really great illustration of what that future could be,” says Hendrickson. “It’s not so farfetched that the things we put on screen here are things that actually could be made in the future. And the Maker Movement is a key to that.” 🚀

3 TECHNIQUES FOR BUILDING SOFT ROBOTS

Want to build your own Baymax? Soft robotics may not be quite ready for health-care robots, but research at iRobot, Otherlab, MIT, Harvard, and Carnegie Mellon is surging ahead. Get started on your own with these three techniques from Carnegie Mellon’s Chris Atkeson, and find many more tips, tricks, and resources at makezine.com/soft-robot-techniques.

1.

Enclose air in sheets of sewn, sealed, material, structured like clothes. One way to experiment is to buy cheap inflatables — or scavenge broken ones — and use the repair kits, a hot air welder, or an impulse sealer to make the seams.

2.

Use 3D design and printing (or machining or cutting) to make more complicated shapes. Working directly with flexible materials can be challenging, but that’s only one approach — you can use these techniques to create molds for other materials.

3.

Carve, sculpt, dip, spray, or mold a soft material, such as silicone. The result won’t be as obviously inflatable as Baymax, but you can equip it with internal bladders and space for actuators, sensors, batteries, and more.

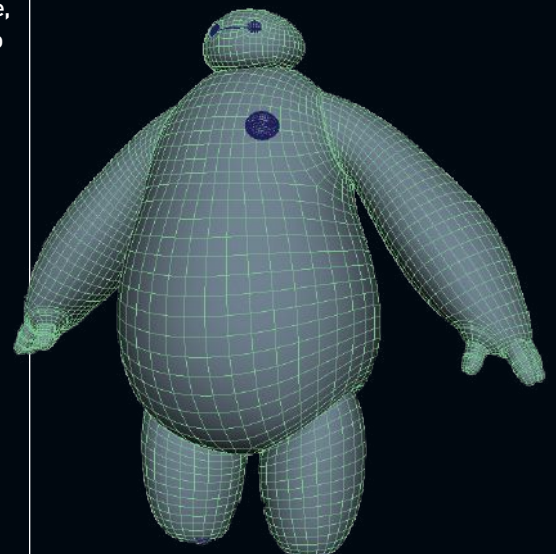

RASPBERRY

PI

Inside

HOW THE NEW COMPUTE MODULE HELPS MAKERS CREATE EMBEDDED LINUX PRODUCTS.

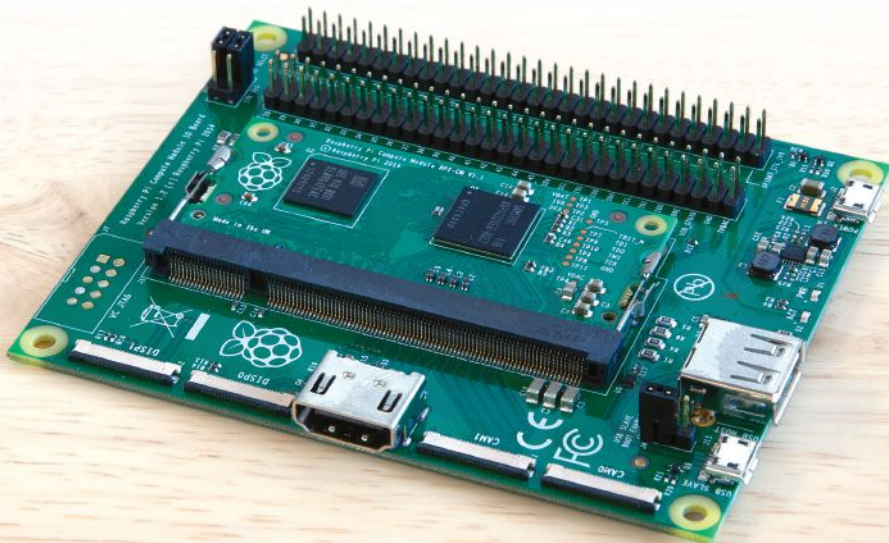

Written by Matt Richardson

MATT RICHARDSON is a San Francisco-based maker and author. He's the owner of Awesome Button Studios, a consultancy focused on blending creativity and technology.

IN AN EXPANSIVE AND NOISY OAKLAND WORKSHOP, THREE COLLABORATORS CREATE A NEW PRODUCT: A HACKABLE CAMERA THAT USERS CRANK TO TAKE ANIMATED GIFS.

More than 5,000 miles away in Sheffield, United Kingdom, a team of developers is working on a sleek new set-top media player based on open technology. In the Netherlands, a voice-controlled home automation project is becoming a product. All three of these groups are integrating Raspberry Pi's new Compute Module into their products, a major leap forward in the accessibility of a powerful technology. With it, fledgling ideas can more easily become reality.

Until now, if you made a Raspberry Pi-based project and you wanted it to become a product, you faced a challenging leap — the chasm between project and product was wide. With more established hardware development platforms and less complex technologies, there's typically a pathway for makers to "go pro."

For example, Arduino is a gateway to programming Atmel's AVR microchips,

Jeffrey Braverman

the silicon at the core of standard Arduino boards. The Arduino platform is popular because it does away with the complicated toolchain and simplifies the process of programming AVR chips. After learning Arduino, makers can advance to creating their projects with the AVR chips alone, essentially using the “brains” of the Arduino and excising any of the features they don’t need — like taking the training wheels off a bike. This leads to the use of Atmel’s chips in products that have their beginnings as maker projects.

The Raspberry Pi Foundation is betting that the same will be true for its inexpensive, single board Linux computer. While the main purpose of the foundation is to advance the education of adults and children in the field of computers, Raspberry Pi has dominated the hobbyist market for inexpensive Linux computers. Commonly found at the core of multimedia and internet-connected projects, the Pi has become the tool makers reach for when they need more power and features than a standard Arduino affords.

With the announcement of the Compute Module in April, the Raspberry Pi Foundation has given makers a platform to prototype and eventually integrate the technology into refined products, much like Arduino users have learned to do. According to the foundation’s announcement, they “want to free the core technology of the Raspberry Pi to go forth and become an integral part of new and exciting products and devices.” Within months of the announcement, crowdfunding campaigns were touting that their upcoming product would have Raspberry Pi inside.

To make this possible, the Raspberry Pi team first had to tackle the size issue. While the Raspberry Pi Model B is small, it’s still too bulky to be integrated into most products. Therefore, they squeezed the core components down onto a much smaller board, making it the same form as a standard DDR2 SODIMM memory module. Much like snapping a RAM module into a laptop’s motherboard, the Compute Module

can be snapped into a custom-printed circuit board. It comes complete with a CPU, RAM, and onboard flash memory, the bare essentials for an embedded Linux device.

To help people get started, the foundation also sells a development kit, including a Compute Module and an I/O breakout board

- to handle power regulation and make the various I/O pins easily accessible. When you snap the Compute Module into the board, you essentially have a Raspberry Pi that’s suited for product development.

Compared to a standard Raspberry Pi, it has more I/O pins as well as additional display and camera connectors.

The Compute Module opens the door to a much larger market. Instead of being useful solely in an academic or hobbyist setting, the Raspberry Pi becomes a practical option for embedded Linux products.

They’re certainly not the first to jump into embeddable “computer on modules.” Gumstix, from Redwood City, California, started shipping Linux-based modules a full decade ago. But Gumstix, along with most other companies that offer a similar product, aim squarely at commercial and industrial applications, not necessarily the maker-gone-pro demographic.

What also sets Raspberry Pi apart from other Linux modules is its user base: With more than 3 million Raspberry Pis in the wild, the community is much larger than that of any other Linux development board. With so many users hammering at new software updates, problems are quickly reported and the foundation has been aggressive about software development.

The large community also means that when someone develops with the Pi, they can leverage the abundance of tutorials, support, code examples, programs, and circuit diagrams that are free online.

For Next Thing Company from Oakland, California, the Compute Module couldn’t have been announced at a better time. They were using Raspberry Pi Model B to prototype a hackable GIF camera, OTTO. Before they heard the news, they debated

"WE'RE MAKING THIS CAMERA, AND I REALLY NEED THAT COMPUTE MODULE."



The OTTO wasn't always so sleek; it went through several prototypes, like this clear one (at bottom), before adopting its present blue body (below). The latest, a folded cardboard version, is a software development kit — the core concept, after all, is for OTTO to be easily hacked.

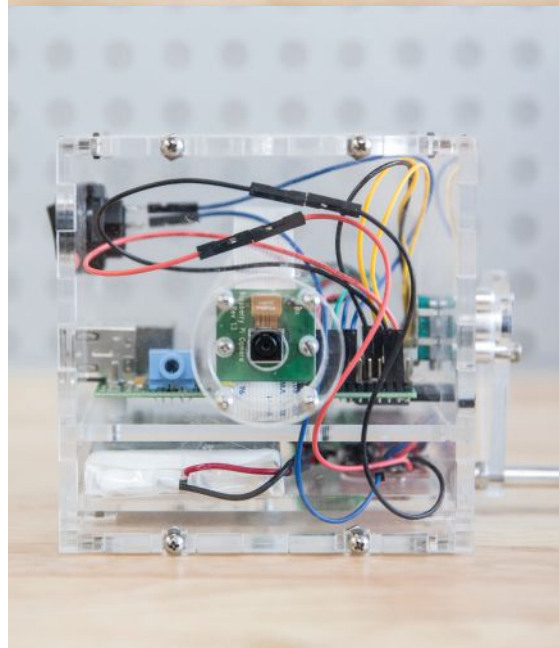

whether to continue with the Model B.

"My feeling at the time was that it's not a real product if it has a Raspberry Pi in it," says Dave Rauchwerk, one of OTTO's creators. "It's something for makers only. It's great, but it's limited in scope, it's a fun way to learn and experiment, but it won't get you to that next step."

But within 24 hours of the Compute Module announcement, Rauchwerk was on the phone with Eben Upton, creator of the Raspberry Pi.

"After I profusely thanked Eben for making the Raspberry Pi in the first place, I said, 'So yeah, we're making this camera and I really need that Compute Module,'" says Rauchwerk.

The Raspberry Pi team was delighted to see The Next Thing Company take the Compute Module and commit to using it so soon after the announcement. It was just the sort of creative project they wanted to see based on the Pi.

"Before, you had to have a big design

department and lots of money to do this," says James Adams, Raspberry Pi's director of hardware. "What really excites me about the Compute Module is the fact that a few guys in a garage can actually do this now. That's usually where all the interesting and inventive stuff comes from."

"It's exactly that kind of fun product that you can't imagine getting through the product approval process at a conventional company," adds Upton. "It's a thing that has to be crowdfunded."

The team behind OTTO showed off an early prototype of the camera at Maker Faire Bay Area, claiming the title of creating the first-ever product to be powered by the Compute Module. The company achieved its

crowdfunding goal of \$60,000 in June and expects to ship the cameras to backers in December, but other groups using the Compute Module are hot on the trail.

Sheffield, United Kingdom-based FiveNinjas quickly exceeded the £90,000

(\$150,000) Kickstarter goal for Slice, a set-top media player based on the Compute Module, which is also scheduled to ship to backers in December. Other than the onboard Raspberry Pi, what sets Slice apart from other media players is the internal hard drive — users can load it up with media to play even when they don't have an internet connection.

FiveNinjas already has an advantage because Raspberry Pi's hardware and software development leads, James Adams and Gordon Hollingworth, are on the team. But the Compute Module itself also benefits from this arrangement. Designing the module and also developing a product around it helps make it better.

"We're certainly insiders with the Compute Module," Adams says. "But it's allowed us to see what the problems are with it when designing a product. We found stuff that we needed to fix with the software, which has been fed back into the Raspberry Pi software stack."

And Upton was happy to allow Adams and Hollingworth to take on Slice as a side project. "They're experiencing the pain of doing a Compute Module-based

"BUILDING EMBEDDED HARDWARE TODAY IS LIKE BUILDING A WEB APP IN 1994."



1. Homey, a connected home base station, automates many of your devices through voice control.
2. Slice, a sleek, portable media player with internal memory, plays audio, displays photos, and even shows HD and 3D video.
3. Opened up, Slice reveals a 1 terabyte hard drive, a Raspberry Pi Compute Module, and a custom-designed



Kickstarter," he says. "They're sanding off some of the rough edges and you can see the software getting better so that the next person coming down the road has a slightly smoother experience."

A company in Holland called Athom is benefitting from this tight feedback loop. Athom will soon release a crowdfunded Compute Module-based product called Homey, a voice-controlled home automation hub. It started as a personal project for Emile Nijssen. He was running the first version of Homey on a Windows computer three years ago, but moved it to a Raspberry Pi for portability. It was around the time that the Compute Module was announced that Nijssen was thinking of turning his personal project into a product.

"We had a few options," he says. "One was to build and design our own board with a system-on-chip on it, but that wasn't feasible in the time frame we had envisioned. The other was to make a shield for the Raspberry Pi or BeagleBone Black, but that's expensive and not at all optimized for a product."

It is exactly that gap that Upton hoped the Compute Module would fill. He sees it as a new stepping-stone toward manufacturing consumer electronics with an embedded Linux system-on-chip (SoC).

"Small businesses haven't had the opportunity to build electronic devices that are competitive with what a large company can build," he says. "We've gone from an era where you can buy 6502's out of a bucket

at a trade show to where everything relies on poorly documented and not generally available SoCs."

Price is another major factor. It's not typically cost effective to work with SoCs unless you're producing in quantities of tens of thousands or higher. "Even if you're smarter than your average consumer electronics company, you've got to be 10 times as smart as they are, because they're paying one tenth of the price for components," says Upton. The Raspberry Pi foundation has fixed the price of the Compute Module so that, whether you're buying 100 or 10,000, it costs \$30 per board.

The foundation's strategy isn't to lock developers into the Raspberry Pi platform, and it's not expecting Compute Modules to be used in mass-produced consumer electronics products. Upton says it would be a success for Raspberry Pi if a product can graduate from the Compute Module and take the next step into using SoCs directly. "OTTO and Slice are two really good examples of the sort of thing that I want to see, which is people doing professional-

quality consumer electronics at a price which is broadly competitive but at volumes that are accessible to a not particularly extravagant crowdfunding campaign."

There's a sense of excitement from the first product developers to use the Raspberry Pi Compute Module. All three of these products are doing something new and uncharted, and they're eager to see what others will do with it.

"Building embedded hardware today is like building a web app in 1994," says OTTO's Rauchwerk. "You have to create all of the tools and all of the infrastructure to build the thing you want to make. We're laying this groundwork for our own products and open sourcing it for others. What kind of things would people make if they didn't have to do all the plumbing first?"

Even its creators are waiting to see what path the Compute Module will take.

"This is a step into the unknown for us. There's a lot of enthusiasm, but I still don't know if it's going to work," says Upton. "But there's a tantalizing feeling that it could be bigger than Raspberry Pi. It's exciting." 🍌

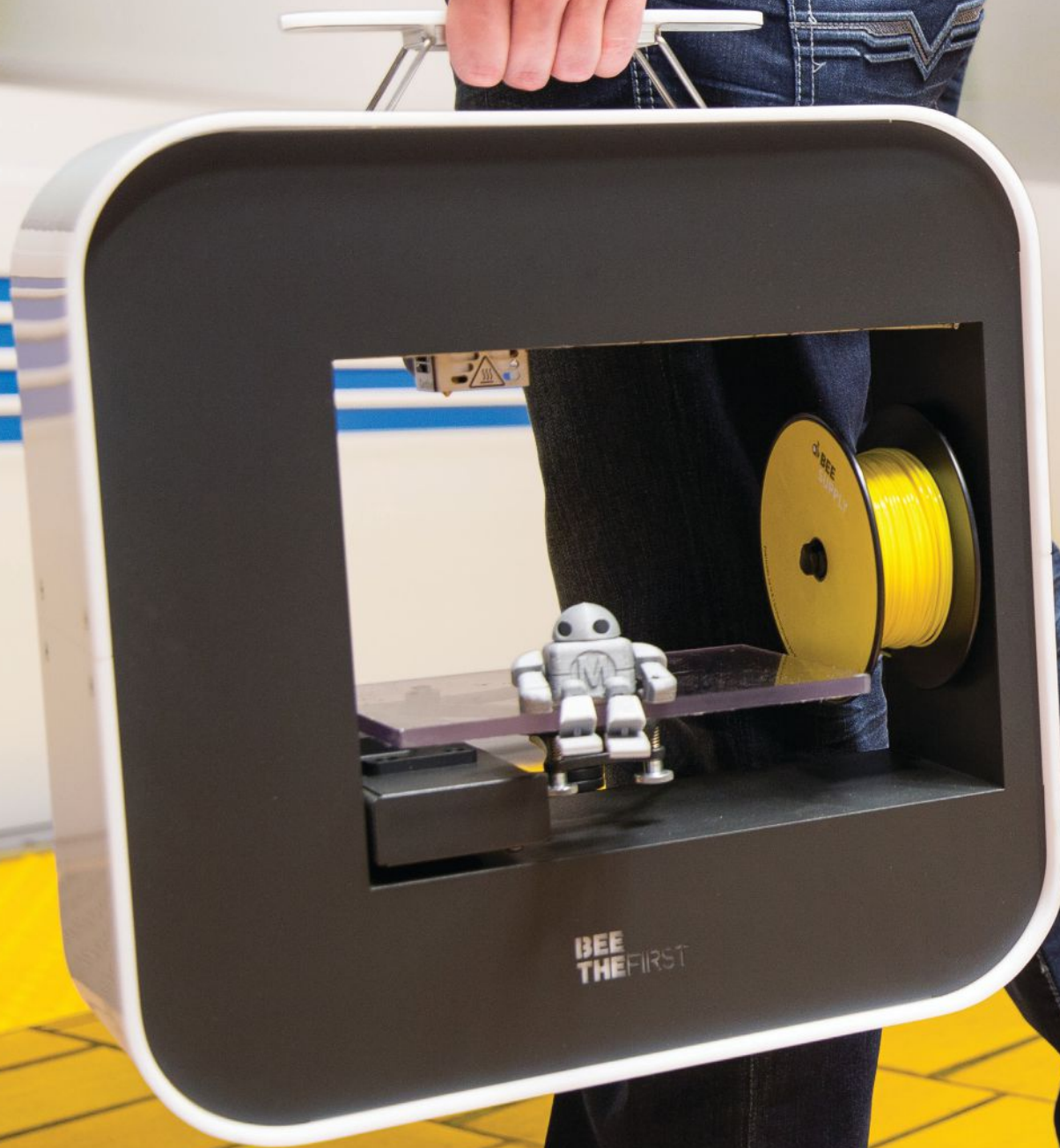

3D EVOLUTION

WRITTEN BY ANNA KAZIUNAS FRANCE

The new printers are much more polished than their predecessors — but are they as consumer-ready as their finish and packaging suggest?

2014 HAS BEEN A FULL-THROTTLE YEAR FOR 3D PRINTING SINCE JANUARY'S CONSUMER ELECTRONICS SHOW (CES) introduced us to dozens of new machines. It's clear that additive fabrication has caught the attention of major brands in all sectors (Adobe, Microsoft, Hasbro, Dremel) and the push for the mainstreaming of this technology has hit a new plateau.

Although there's been a lot of hoopla, most of the changes to actual functionality have been small; with slow and steady improvements being made to existing (and sometimes cloned) hardware,

software, and documentation. Many machines are still in the adolescent stage, but a few have blossomed early, and their polished appearance has begun to attract wider consumer attention.

When unpacking the machines that were tested in our third annual Shootout weekend, I immediately noticed a dramatic, consumer-product-style change in machine packaging and overall fit and finish. Printers once arrived in packing peanuts and were made of laser-cut plywood, now most are shipped with custom foam inserts reminiscent of desktop computer packaging with bodies

made of injection-molded plastic. These machines are slowly evolving, but does their performance meet the expectations set by their consumer-ready facades?

We were keen to find out. The core group of 3D-printing test-team veterans (some of whom have been present at all three Shootouts) began preparing more than a month before our trip to this year's new location at America Makes in Youngstown, Ohio. With the addition of 3D-printing research scientist Andreas Bastain, our test methods advanced from mere visual inspections of Thingiverse objects. We drafted a flexible

evaluation protocol and created parametric models that could be quickly adapted to any unexpected situation. These preparations, combined with the onsite, real-time, data-crunching diligence of Kacie Hultgren (aka Pretty Small Things) has yielded quantified comparison data that we could only dream of previously.

As you read through our reviews, you will see two distinctly different, complementary types of data: the quantified print-quality scores and the qualitative evaluation of our team's personal experience with each machine. As with last year's testing, each machine was run by several different 3DP experts to ensure that personal preferences did not skew the results, and we systematically and anonymously contacted customer support. The materials, host, and slicing software listed on each review are manufacturer recommended, but we verified hardware and software openness by tracking down the source files and their licenses.

We're proud of what we've accomplished during this year's testing, although there's always room for improvement. We used Ultimachine orange PLA as a control variable (the team agreed that it was a solid, widely available choice, representative of what would commonly run through desktop machines), some exceptions had to be made (noted in our print-quality summary) for machines that refused to function or jammed without proprietary filament.

In addition, our fused filament fabrication XY and Z resonance mechanical tests did not yield the granularity they were designed to collect and were downgraded to weighted Pass/Fail scores. Many of our SLA tests proved to be too far too ambitious and were abandoned. That may sound bleak, but it was all part of the plan — as Andreas relates on page 34, these models were *designed* to fail.

Why does all this matter? Because — as Kacie states on page 36 — “consumers want accurate prints at the push of a button” and consumer adoption of 3DP (with lower prices and widespread technological transformations that their adoption could enable) is directly dependent on how we answer two key questions: “What is print quality?” and “What should we expect from our 3D printers?” 🗨️

An Old-Fashioned American Shootout



DURING THE 2013 STATE OF THE UNION ADDRESS, PRESIDENT OBAMA referenced the National Additive Manufacturing Innovation Institute (NAMII) in Youngstown, Ohio as a new program to look at for economic inspiration. A year and a half later, *Make:* chose to conduct its annual 3D-printer tests at their location as a way to help connect a traditional manufacturing community with the Maker Movement.

Located inside a once-shuttered furniture factory, the institute, re-named America Makes in October 2013, honors the city's industrial past while embracing a technological future. Aiming to become a center point of research and development for the rapid-moving world of 3D printing, it teaches its workers to be experts in all areas of additive manufacturing — from desktop to industrial — while offering knowledge and facilities to companies and universities who are looking to bolster their capabilities.

As promised, the venue and its collection of top-level machines, able to turn powdered metal or nylon into anything from rocket nozzles to windmills, is very inspiring. After our weekend of testing, America Makes' founding director Ralph Resnick opened the doors to the public. The look of excitement on the faces of the visitors, many of them hopeful for an economic resurgence in the Steel Valley, made it clear that the program is headed in the right direction.

—Mike Senese

FREEDOM. NO EXCEPTIONS.

Introducing LulzBot Mini.

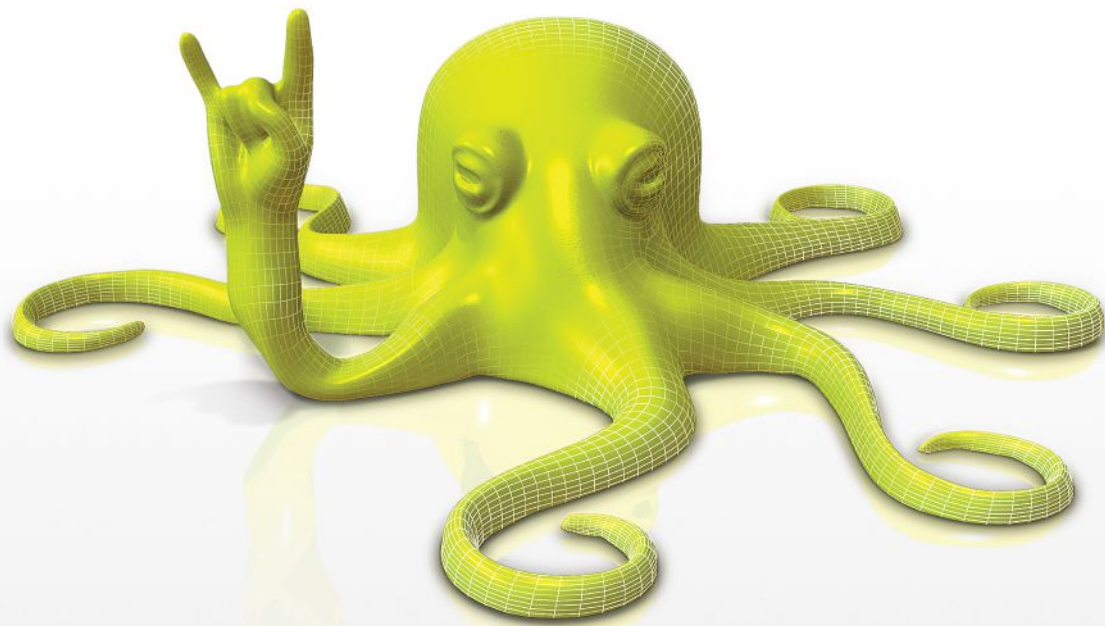

lulzbot.com/mini

WHAT IS PRINT QUALITY?

Testing to failure and quantitative methods are more informative than visual inspection

WRITTEN BY ANDREAS BASTAIN



ANDREAS BASTAIN is a 3D-printing research scientist at Autodesk, where he studies both novel and established 3D-printing technologies. He's conducted research in nylon SLS (openSLS project), direct metal laser sintering (DMLS), novel extrusion technologies, mesostructured materials, and traditional 3-axis FFF technologies. He is also an active member of the e-NABLE prosthetics community. He developed the test prints and evaluation protocols used at this year's 3D printer Shootout. andreasbastian.com

TRADITIONALLY, DESKTOP 3D PRINTER MANUFACTURERS HAVE DISCUSSED

print quality and precision in terms of layer height. While layer height does play a role in print quality, it is just one (and a small one at that) of several measurable contributors to overall perceptions of quality. Print quality is a combination of visual perceptions and functional characteristics, such as dimensional accuracy, surface finish, overhang capabilities, deposition control, motion mechanics, motion control, material properties, and slicing algorithms. These factors are interrelated and adjusting one affects others, making it somewhat difficult to identify each one's contribution to overall print quality. However, it's possible to create test geometries that probe specific components of print quality and to individually evaluate those geometries while holding all other variables constant, allowing for a more quantitative and parametric assessment of print quality than could be achieved by comparing any number of more traditional printed models.

WHY THIS SET OF GEOMETRIES?

Each model was designed to carefully probe a single aspect of print quality. While not exhaustive, they test key aspects that are most closely related to perceptions of quality as well as functionality and performance. Each geometry was optimized for minimal material consumption and minimal print time.

Additionally, some probes, like the positive fine feature test and the overhang test, are designed to coax the printer into a failure state (extruder jam or geometry compile breakdown). Testing to failure generates more information than other testing strategies, offers a quantitative framework for evaluating print results, and allows for shareable evaluation protocols. Instead of subjectively evaluating how "blobby" a fine feature test is, you can create features

EACH MODEL WAS DESIGNED TO CAREFULLY PROBE A SINGLE ASPECT OF PRINT QUALITY.

that will reliably push the extruder into a failure state during printing. When the print fails, you can quantify the point of failure by measuring the height of failure with a set of calipers.

WHY NOT JUST MAKE ONE BIG TEST PRINT?

It's often tempting to integrate all test features into one piece of geometry. While in some cases this is viable, combined geometry test prints are incompatible with testing to failure. Failed geometry may interfere with the proper compiling of other model features. Additionally, mixing test features changes the conditions under which the features are printed. For example, overhangs compile best when the previous layer has a chance to cool before the next layer is deposited. In a combination test print, overhang features may have additional time to cool between layers, potentially improving the printer's performance on the feature. When testing overhangs in isolation, each layer has the same (and minimal) amount of time to cool, making for consistent and challenging conditions for each overhang angle. If the machine can compile all the overhang angles under these demanding conditions, it won't have trouble with more integrative combined geometries.

WHAT DID THIS MEAN FOR THIS YEAR'S SHOOTOUT?

In addition to evaluating this year's crop of desktop 3D printers using more quantitative methods, we are sharing all the test prints and evaluation protocols at makezine.com/go/print-quality so that others can replicate our results. The exciting implication is that changes to software, mechanics, and materials can now be correlated with changes in a specific quality performance quantity, providing a methodical, quantitative framework for evaluating and improving print quality. ✓



DIMENSIONAL ACCURACY TEST: Probes a printer's ability to fabricate dimensionally correct geometries in the XY plane. Reveals backlash in X and Y directions if present.

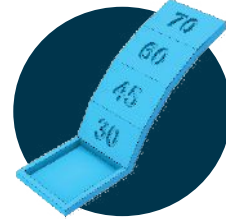

OVERHANG TEST: Tests printer's ability to compile overhangs at 30, 45, 60, and 70 degrees.

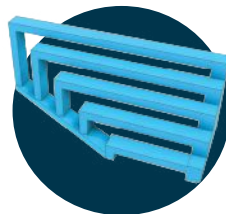

BRIDGING TEST: Gauges printer's ability to span unsupported horizontal gaps of 20mm, 30mm, 40mm, 50mm, and 60mm.

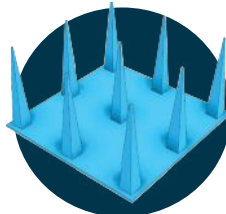

POSITIVE FINE FEATURE TEST: Tests printer's ability to resolve fine features (from 3mm square to 0.4mm square).

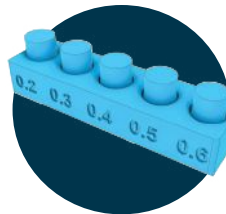

TOLERANCE TEST: Quantifies printer's ability to resolve fine negative-space features in the XY plane, specifically the clearance between a captive pin and a hole.

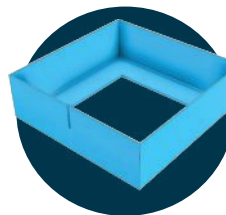

XY RESONANCE TEST: Tests the printer's ability to resolve single-extrusion width features and exposes resonance in the XY gantry.

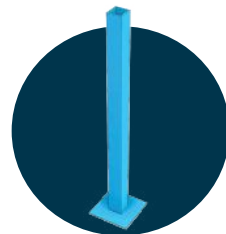

Z RESONANCE TEST: Exposes mechanical issues in the Z motion system.

PRINT ⁻ⁱⁿ⁻ PLACE:

THE ADDITIVE HOLY GRAIL

Prepare to 3D print movable parts and joints

WRITTEN BY KACIE HULTGREN



KACIE HULTGREN, better known as "Pretty Small Things" in the online 3D-printing community, is a multi-disciplinary designer focused on set design for live performance. She is a lynda.com author, recording video tutorials about 3D printing and CAD. She is passionate about teaching others to use digital tools and hardware to augment traditional craft and bring their ideas to life in three dimensions. @KacieHultgren kaciehultgren.com



PRINT-IN-PLACE MODELS ARE THE HEIGHT OF DESIGN FOR 3D PRINTING. These objects incorporate various types of joints, moving parts, and hinges that sometimes unfurl into designs much larger than the printer's build area. Sharing platforms like Thingiverse and Youmagine now showcase a wide variety of design strategies that embrace and push filament-based desktop 3D printers to their limit.

In the last few years, desktop 3D printers have become increasingly more sophisticated, but not all 3D printers can reproduce the same results. While printer manufacturers put a lot of emphasis on layer resolution in their sales materials, layer height has little to do with successful PIP prints. The overall stability of a printer can have an effect — printers that experience issues with backlash, lack a rigid frame, or require frequent belt tensioning will certainly struggle. But the diversity of the results can be mostly attributed to the software layer. Slicing software does more than merely create the digital instructions for the 3D printer — slicers *interpret* the design — and each program uses different algorithms.

Slicers have eccentricities. Some are finely tuned to print bridges or easily removable support material. Others have a tendency to produce zitty surfaces, unsightly zippers, or have thin top surfaces. Individual profiles have an even greater effect, multiplying these innate issues.

Many of these aberrations can be attributed to the fact that there is no design standard. Designers individually create PIP designs to work with their printer. Through trial and error, they discover the right tolerances for their own preferred make and model. A designer optimizing for a MakerBot Replicator slicing with MakerWare might develop

a different set of personal guidelines than a designer slicing with Cura for an Ultimaker, or a LulzBot TAZ using Slic3r. Samuel N. Bernier's articulated robot (used in our testing) is a smart but extreme example of



Jeffrey Braverman

HAVING TROUBLE WITH A PRINT-IN-PLACE DESIGN?

Here are some things to try:

- **Adjust the Z-offset.** If the nozzle is too close to the platform on the first layer, the joints will fuse.
- **Adjust filament diameter.** If your filament is thicker than average, your nozzle could be extruding too much plastic. Measure your filament in several places with calipers and enter the average into your slicer. Or, just bump up the value by a few tenths of a millimeter.
- **Create test prints and tune a profile.** Design test prints that re-create the bridges or gap tolerances that are causing trouble, and adjust your profile before you tackle a time-consuming print.
- **Adjust your extrusion width.** If the design has been created with a specific wall thickness, try adjusting your extrusion width to match. Most printers have nozzle sizes between 0.35–0.5mm, and their default extrusion widths are different. On prints with thin walls, this makes an impact.
- **Is it parametric?** If the designer made the gap tolerances in their design adjustable, adjust to suit.

a print-in-place design. The individual parts that make up the limbs have a gap of just over 0.3mm — if a printer can't accurately print that gap, the joints will be fused together. The arms have overhangs of 65°, which, while in the range of possibility, are a challenge for many machines. Another tough spot are the hinged limbs, which are created with short bridges. It's not a coincidence that many of these qualities were tested in our review process with individual test probes. If a printer isn't set up to create flawless bridges, smooth overhangs, or accurate-sized parts, it won't have a chance on a PIP design like the LeFabShop robot. In our testing, there were few printers that could print this design flawlessly with stock settings.

If we want a future where 3D-printed products are ubiquitous in our homes, we need great designs. Not just useful replacement parts, but products that have just as much thought and development as the ones we buy off the shelves. The most unique will utilize challenging features, like overhangs and bridges, to push our printers to their limits. Additionally, consumers will expect accurate prints with the push of a button. The current culture of tweaking and calibrating won't extend past the maker audience.

The growing diversity of both hardware and slicing software runs counter to a goal of universal printability. The solution might be found in design software. Programs like OpenSCAD, Autodesk Inventor, and SolidWorks can create adaptable, parametric designs. By changing values for elements like gap tolerances, designers can create variations to work with multiple printers. Web interfaces like Thingiverse's Customizer let the consumer easily adapt a design on their own. Unfortunately, not all software or design workflows include parametric features.

Print-in-place designs like the LeFabShop robot test our assumptions. For our test team, the results of the print-in-place test provoked more questions than it answered. What do we expect from a 3D printer? And is there a future where we can expect all 3D printers to perform to the same threshold? 🤖



Anna Kazunas France

ULTIMAKER 2

Best in Shootout for overall print quality

WRITTEN BY ELI RICHTER Available at [MakerShed](http://MakerShed.com) bit.ly/ultimaker-2-printer

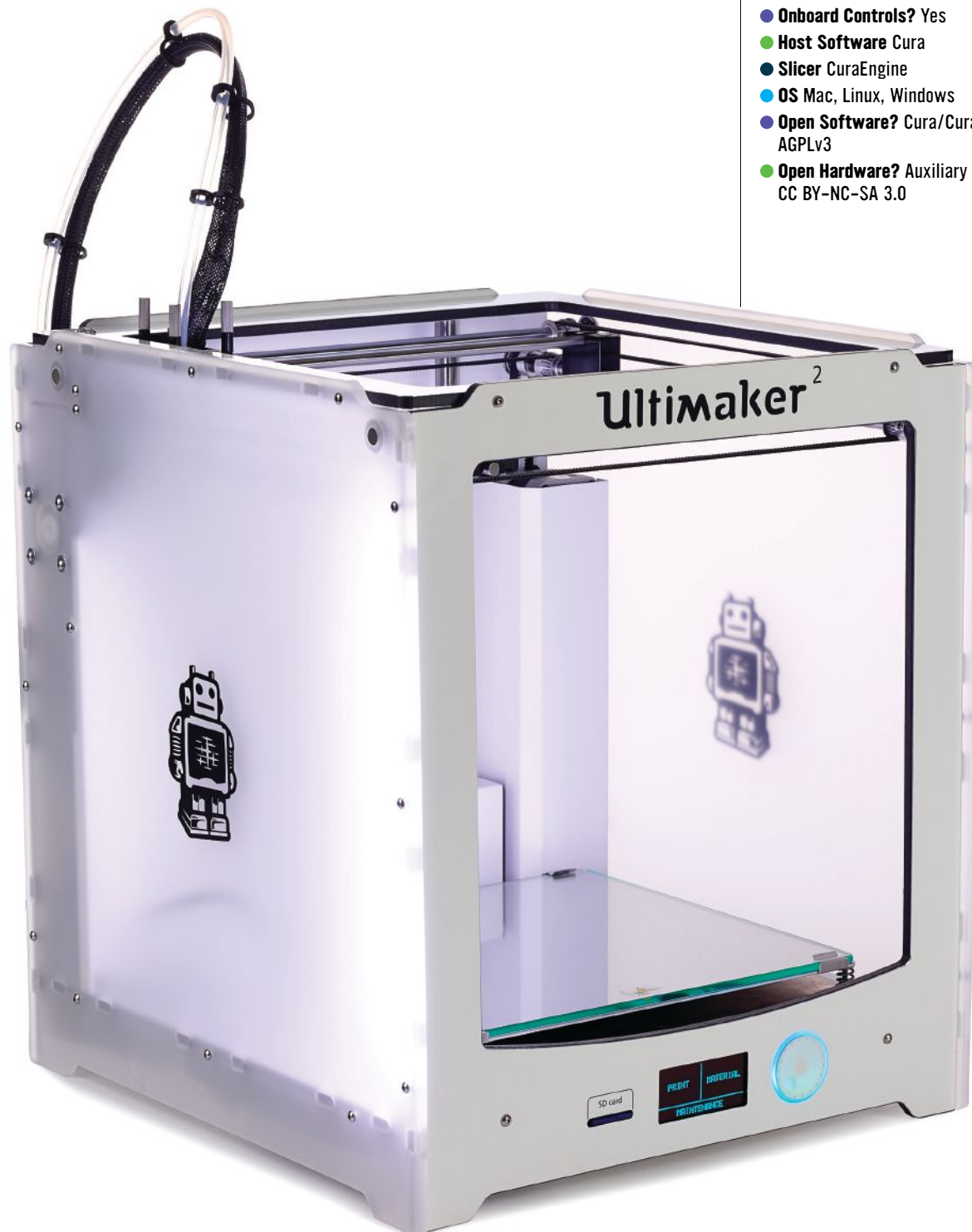

Ultimaker | ultimaker.com

- Price as Tested \$2,499
- Build Volume 230×225×205mm
- Bed Style Heated glass
- Temperature Control Yes
- Materials PLA, ABS (others encouraged)
- Print Untethered? SD card, OctoPrint compatible
- Onboard Controls? Yes
- Host Software Cura
- Slicer CuraEngine
- OS Mac, Linux, Windows
- Open Software? Cura/CuraEngine: AGPLV3
- Open Hardware? Auxiliary design files: CC BY-NC-SA 3.0

ALTHOUGH ULTIMAKER'S SECOND OFFERING RECENTLY CELEBRATED ITS FIRST BIRTHDAY, its performance in our Shootout was head and shoulders above the rest of the FFF machines. This is a great machine for those who want to load a model and print without spending hours setting up and tweaking parameters, but it still gives the advanced user enough control to get even more out of the Ultimaker 2. Ultimaker also maintains its own integrated 3D-printing ecosystem, with an online model library at YouMagine.com and web-based modeling tool UltiShaper 3D.

GREAT OUT OF THE BOX

The Ultimaker 2 ships almost entirely pre-assembled and ready to go. Simply remove the (awesome) glass build plate from its protective bubble wrap, and secure it with the premounted aluminum clips. Snap on the filament holder, power it on, run the leveling procedure, load the filament, and this bot's ready to go. Bed leveling is performed manually using the familiar "paper thickness" ritual, and onboard menus on the OLED screen quickly guide the user through the process. While auto-bed leveling would be a welcome feature, the 3-point system (versus a 4-point system where two knobs must be adjusted in tandem) works very well and the adjustment knobs turn smoothly, making fine-tuning a breeze.

Models are prepared for printing with Cura, Ultimaker's open-source software, and files are written directly to an SD card. Software configuration is simple: Just select your printer from a list of preconfigured options. For those who want to just load a model and print, Cura's default streamlined "Quickpoint" mode displays three basic print quality options: fast, normal, and high quality. More adventurous users can switch the software into "Expert Mode," which opens up a multitude of tweakable settings. Normal mode works great for most prints, but it can be a bit fast for smaller models. Prints are run directly from a computer SD card using the onboard controls.

Using the stock settings, this printer

was at the head of the pack for most of our test prints, notably those that tested the physical stability of the machine. Tests with lower scores, such as the Overhang and Bridging prints, were hurt by the aggressive speeds and could be vastly improved with some minor tweaking.

FEATURE PACKED, OCTOPRINT COMPATIBLE

The Ultimaker 2 has all of the features one should expect of a class-leading printer: a heated glass build platform, illuminated build area, onboard controls, two PLA cooling fans, with a frame that is sturdy and attractive. It's also OctoPrint compatible, so wireless printing (and slicing via Cura) is possible with the user addition and setup of a Raspberry Pi and a wi-fi dongle. Absent from this feature list is an autoleveler and second extruder, which though in development, was not yet available as of press time. If a dual extruder is on your immediate must-have list, then you may want to wait. However, Ultimaker has always included a spot in their extruder carriage for the possible addition of a second one, so upgrades of this machine are feasible.

ONE HAS TO DIG DEEP TO FIND THINGS NOT TO LIKE ABOUT THE ULTIMAKER 2.

NOT QUITE PERFECT, BUT DARNED CLOSE

One has to dig deep to find things not to like about the Ultimaker 2. During the Shootout, we had two thirds of the build area LEDs fail (I told you, we're digging deep). Feeding material into the extruder can be tricky and the fans on the hot end assembly are a little loud — unfortunate for this otherwise quiet printer. Ultimaker was responsive when we anonymously contacted their support about the faulty LED strips, offering advice to troubleshoot and replacement units.

CONCLUSION

Makers on a tight budget may want to look elsewhere, but few machines can beat the Ultimaker 2's combination of high-quality, hassle-free printing with easy-to-use software and an attractive, compact package. 🍌

PRINT SCORES

● Accuracy	1	2	3	4	5
● Backlash	1	2	3	4	5
● Bridging	1	2	3	4	5
● Overhangs	1	2	3	4	5
● Fine Features	1	2	3	4	5
● Surface Curved	1	2	3	4	5
● Surface General	1	2	3	4	5
● Tolerance	1	2	3	4	5
● XY Resonance	FAIL	PASS			
● Z Resonance	FAIL	PASS			

PRO TIPS

- Reduce printing speed for small parts or tweak settings in Cura to set minimum layer time.
- Use a glue stick to keep large overnight prints adhered to the platform — brims and rafts can be difficult to remove.
- Back filament from hot end manually (heat nozzle, move material, remove tube and trim before executing "change filament procedure") to avoid melted chunks jamming filament feed.

WHY TO BUY

Best in Shootout print quality. Killer heated glass bed is perfect for PLA prints, also works well with ABS, Bridge Nylon, PETT and T-glase. Beginner-friendly software, but also offers complete setting control. Onboard controls allow for fine-tuning of temp and speed settings midprint.

How'd it print?



ELI RICHTER is an engineer by day and maker by night. He is a core member of HackPittsburgh where he manages and maintains their 3D-printer program. Other projects include running HackPittsburgh's PPPRS racing team, Hack to the Future. elijahrichter.wordpress.com

TAZ 4

Thoughtful construction, great prints,
libre hardware

WRITTEN BY MATT STULTZ

TAZ 4 | lulzbot.com

- Price as Tested \$2,195
- Build Volume 298×275×250mm
- Bed Style Heated glass
- Temperature Control? Yes
- Materials ABS, PLA, HIPS, PVA, and wood filaments
- Print Untethered? SD card, OctoPrint compatible
- Onboard controls? Yes
- Host Software Printron
- Slicer Slic3r
- OS Mac, Linux, Windows
- Open Software? Third-party software
- Open Hardware? GPLv3 and CC-BY-SA 4.0

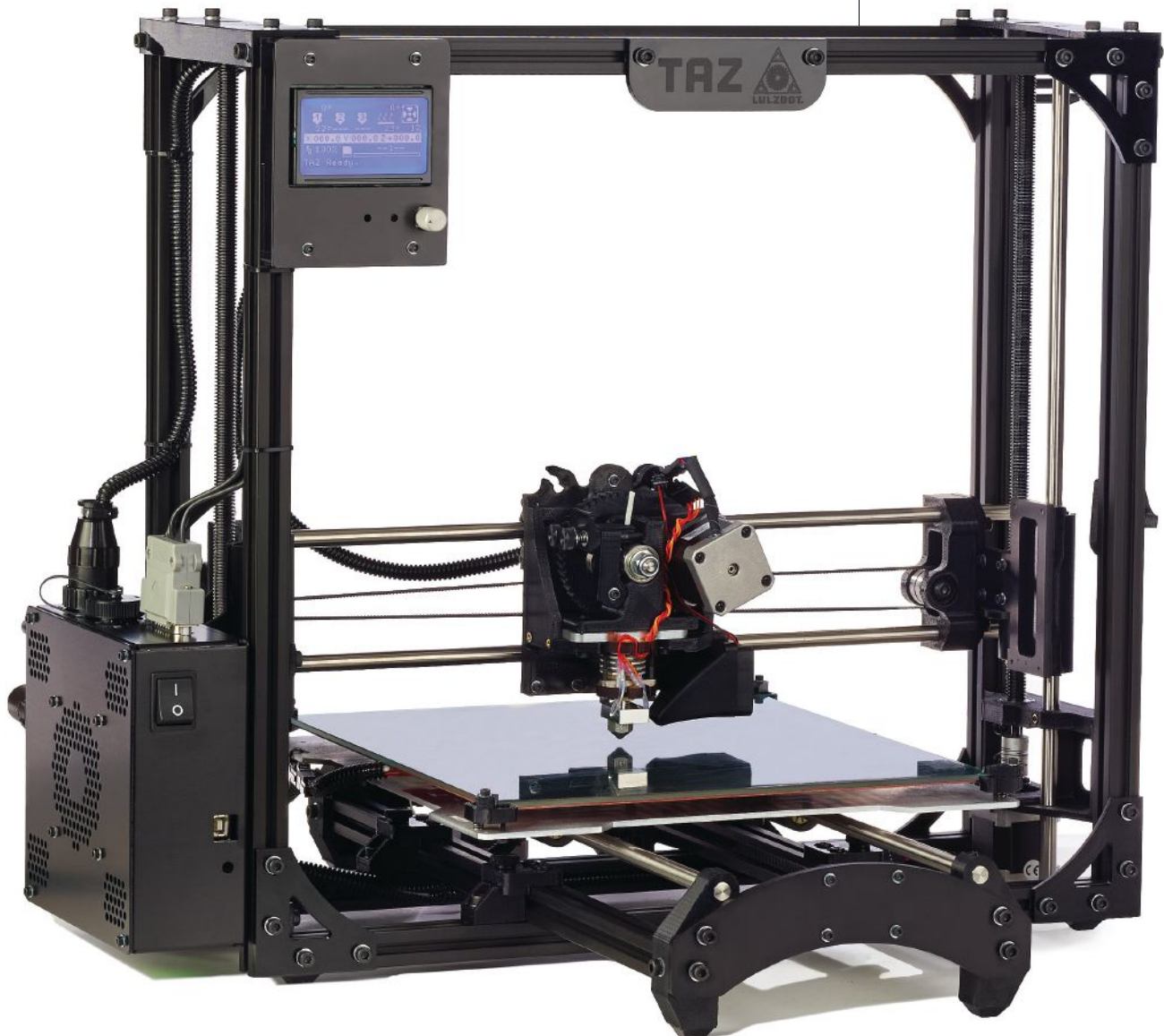

THE LULZBOT TAZ 4 WAS HIGH ON MY LIST OF PRINTERS TO TEST THIS YEAR. I

have always been impressed with the engineering and attention to detail that LulzBot has put into its machines. Having spent some time on the original TAZ during last year's testing, I wanted to see what improvements had been made. I expected a printer that the hackers would love — capable of producing large prints that are perfect for demos and parts. I didn't expect a machine that would print high-quality prints on par with any other machine on the market. I was pleasantly surprised!

MINOR ASSEMBLY, FOOLPROOF CONNECTORS

Unpacking the TAZ 4, you will find the printer mostly assembled but with a few of the parts packed separately for easy shipment. You will also find a quick-setup guide, a larger manual, a spool of filament, and an excellent toolkit. Assembly is a snap — the TAZ 4 uses high-quality connectors that make the wiring foolproof. Most of the parts can be assembled by hand, but the few that can't are easily completed with the included toolkit. With the help of the quick-start guide, you will be up and running with your first prints in about an hour.

BY ENGINEERS, FOR ENGINEERS

In a field of printers that are starting to spend a serious amount of effort on their design aesthetics, the LulzBot TAZ 4 isn't going to be winning any beauty pageants — it's been designed by engineers for engineers. The creators took time to not only figure out how to do the things they wanted but how to do them the best way. The spool holder is hinged to hide away during transportation or storage, but swivels down and locks in place for use. The filament guide snaps onto its holder and can adjust with the movements of the machine. In most printers we find that

screw holes are either tapped directly into the plastic or have nuts on the backside to hold the bolts in place. The TAZ uses press-fit brass threaded inserts that ensure all connections stay rock solid. Instead of using the standard steel roller bearings for linear motion, the TAZ uses igus polymer bushings. These bushings run quieter and without lubrication, resulting in zero maintenance and a longer lifespan.

KEEPING IT OPEN SOURCE

As more printers hit the market as closed-source projects, LulzBot has continued its commitment to manufacturing a fully open-source printer. All of the files — their source files, schematics, and code — are available for you to fix, build, and redesign any portion of the machine. They also support a large number of the slicing and control software options that are available for the OS printers. LulzBot's site includes config files for the popular open-source Slic3r engine tuned for numerous materials, making it simple to start printing in ABS, PLA, NinjaFlex, and others.

Even the printed manual that comes with the TAZ is open source. If you get nothing else out of this review, download (bit.ly/taz-manual) and take a look. Many sections are nonprinter specific and are perfect for anyone interested in 3D printing. If you use Slic3r this is a must-read!

CONCLUSION

So who is the TAZ 4 a perfect printer for? While I'm hesitant to say this is a printer for a first-time printer owner, the quick-start guide and manual make it easy for anyone to get this machine up and running. Makers, hackers, engineers, and artists will feel right at home with this machine. The large, heated glass build platform, ability to print untethered, and ease of modification will give them everything they are looking for. Sometimes it's best to spend your time on engineering rather than good looks. 🍷

SOMETIMES
IT'S BEST TO
SPEND YOUR TIME
ON ENGINEERING
RATHER THAN
GOOD LOOKS.

PRINT SCORES

● Accuracy	1 2 3 4 5
● Backlash	1 2 3 4 5
● Bridging	1 2 3 4 5
● Overhangs	1 2 3 4 5
● Fine Features	1 2 3 4 5
● Surface Curved	1 2 3 4 5
● Surface General	1 2 3
● Tolerance	1 2 3 4 5
● XY Resonance	FAIL PASS
● Z Resonance	FAIL PASS

PRO TIPS

- The quick-fit extruder makes upgrades a snap. LulzBot already makes a flexible filament extruder and promises a dual extruder upgrade soon.
- Even if the TAZ isn't for you, download the manual at bit.ly/taz-manual, it's packed with info on Slic3r and 3DP tips.
- Download the Slic3r config files from LulzBot's site to get printing in a wide variety of materials quickly.

WHY TO BUY

Large print area with a heated glass bed makes print removal easy and supports most materials. It's totally open source, extremely well engineered, has a quick-exchange extruder system, an amazing manual, and a top-quality toolkit. It produces excellent prints in a wide variety of materials and has an extruder upgrade made for flexible filaments.

How'd it print?



MATT STULTZ is a community organizer and founder of both 3D Printing Providence and HackPittsburgh. He's a professional software developer, which helps fuel his passion for being a maker! 3DPPVD.org

PRINTRBOT SIMPLE METAL

Last year's portable "best value" returns with some serious upgrades

WRITTEN BY LUIS RODRIGUEZ

Available at [Maker Shed](https://www.makershed.com) bit.ly/printrbot-metal

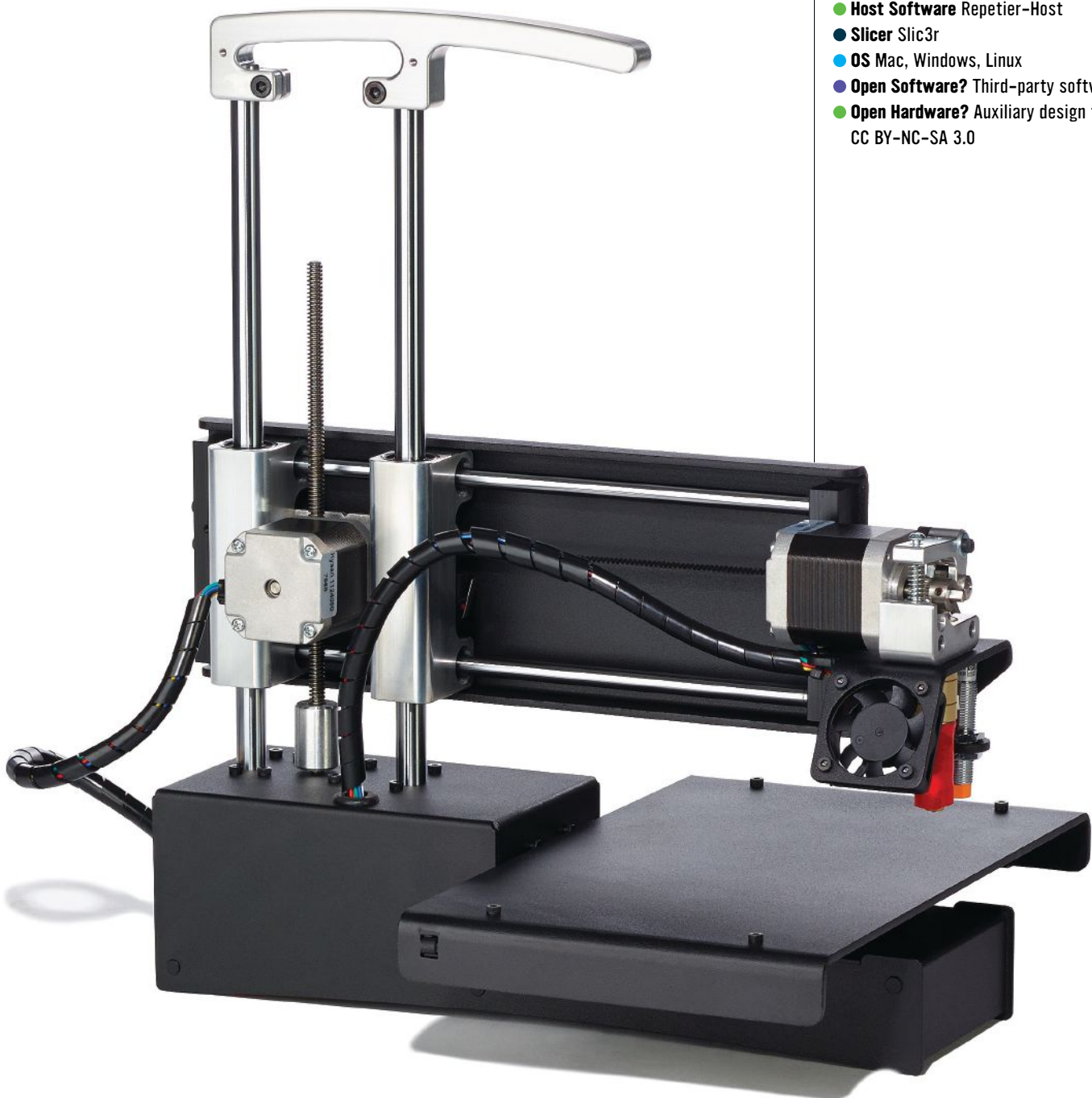

Printrbot Simple Metal | [printrbot.com](https://www.printrbot.com)

- **Price as Tested** \$599 (plus \$39 for metal handle)
- **Build Volume** 150×150×150mm
- **Bed Style** Unheated steel (heated upgrade available)
- **Temperature Control** Yes
- **Materials** PLA (ABS if heated bed)
- **Print Untethered?** MicroSD, OctoPrint compatible
- **Onboard Controls?** No, but LCD add-on available
- **Host Software** Repetier-Host
- **Slicer** Slic3r
- **OS** Mac, Windows, Linux
- **Open Software?** Third-party software
- **Open Hardware?** Auxiliary design files: CC BY-NC-SA 3.0

THE ALL-METAL CONSTRUCTION OF THE PRINTRBOT

SIMPLE METAL feels more like a professional power tool than an entry-level 3D printer. The weight of this small, portable printer gives it a real sense of quality, and the inclusion of a now-standard auto-leveling bed makes it a real step up from its wooden predecessors. This printer is packed with features and rivals machines costing much more.

SAME GREAT VALUE, NOW ALL METAL

Upgrades from the original Simple (still sold as an upgraded “Maker’s Kit”) include a larger build platform that measures a healthy 150×150×150mm, a powder-coated steel frame, thicker polished guide rods, large linear bearings that are seated in machined aluminum carriage, and an all-aluminum, direct-drive extruder that includes a UBIS hot end with interchangeable tips. Our assembled review unit also came with an aluminum handle (\$39 upgrade) with an integrated printed spool holder (free).

MANY OPTIONAL UPGRADES AVAILABLE

With the healthy-sized bed you can print many substantially sized items in PLA and nylon on the unheated surface. ABS is supported if you add the optional heated bed upgrade. In fact, the heated bed upgrade (\$99) and the interchangeable tips (ranging from 0.25 to 0.75mm for \$8 each) allow you to experiment with just about any material. You can print tethered via Repetier-Host, untethered via onboard microSD card, or add onboard controls with the Printrbot LCD control kit accessory (\$65). Don’t forget to print the fan shroud upgrade, it enabled our test unit to attain perfect scores on the Bridging and Overhang tests.

IMPROVED DOCUMENTATION, GREAT SUPPORT

The Simple’s setup documentation is professional and thorough. Due to the amount of information presented, it can feel a bit overwhelming, but it’s a fantastic reference when needed. Printrbot also has a robust help site (help.printrbot.com) and

THIS PRINTER IS PACKED WITH FEATURES AND RIVALS MACHINES COSTING MUCH MORE.

community forum (printrbottalk.com), and it’s common to the see the Printrbot’s founder, Brook Drumm, answering questions directly. That’s a nice customer service touch. There’s also a great education section for teachers and students (learn.printrbot.com).

A FEW MINOR ISSUES

The Simple Metal is pretty great, but it’s not perfect. The initial adjustment of the auto-level probe is a tad cumbersome. It takes a bit of double-hand holding to adjust the probe while fighting the tension on the wiring in the close quarters around the adjustment nuts. The inclusion of a laser-cut wrench helps, and is a nice, sentimental reminder of Printrbot’s beginnings. In addition, it can be hard to tell if the printer is turned on until you notice the glow from underneath the machine. This was not immediately apparent in a well-lit room. We also had a serious nozzle clog issue during an 8-hour overnight print that resulted in the filament forcing its way out of the extruder in a bizarrely perfect, spring-like coil.

Although it’s a common open-source toolchain issue not directly related to Printrbot, it can be a frustrating experience for a first-time user to walk through Slic3r’s multiple setup screens and dialog boxes. I’d like to see Cura formally recommended as another open-source option, as the Printrbot community already recommends it. I also was not impressed with the “write to SD” function of Repetier-Host; I took the microSD card out and loaded it into the computer to transfer the file manually, although it’s a bit hard to access.

CONCLUSION

This printer is a joy and doesn’t feel like an entry-level machine at all. I recommend this printer daily to visitors to Science City, explaining it has many features of higher-priced printers (plus some they don’t offer). This resonates with educators and budget-conscious parents. It’s also perfect for my friends at the local hackerspace, many of whom have spent quite a bit more on machines that don’t have the print quality or the fit and finish of the Simple Metal. 🍌

PRINT SCORES

● Accuracy	1	2	3	4	5
● Backlash	1	2	3	4	5
● Bridging	1	2	3	4	5
● Overhangs	1	2	3	4	5
● Fine Features	1	2	3	4	5
● Surface Curved	2	3	4	5	
● Surface General	1	2	3	4	5
● Tolerance	1	2	3	4	5
● XY Resonance	FAIL	PASS			
● Z Resonance	FAIL	PASS			

PRO TIPS

- During Slic3r setup, measure your filament diameter. Add 0.1mm to avoid a known bug and perfectly adjust your extrusion.
- Print the fan shroud from printrbot.com/project/simple-metal, it will greatly improve every print thereafter.
- Avoid Repetier-Host’s “write to SD” — manually transfer files to SD from your computer’s SD reader.

WHY TO BUY

It’s feature-packed, portable, and solidly built. With its high print scores and many available upgrades, the Simple Metal is a great value for beginners and experts alike.

How’d it print?



LUIS RODRIGUEZ is the lead organizer for Maker Faire Kansas City and has been 3D printing since 2009, when he got his first MakerBot Cupcake. Luis works at Science City, where he manages the Maker Studio and Spark!Lab. unionstation.org/sciencecity

DITTO PRO

Easy for beginners. Plus, attractive, affordable, and tinkerer-friendly.

WRITTEN BY JOHN ABELLA



DITTO PRO | tinkerine.com

- Price as Tested \$1,899
- Build Volume 220×165×220mm
- Bed Style Unheated glass
- Temperature Control Yes
- Materials PLA
- Print Untethered? SD card, OctoPrint compatible
- Onboard Controls? Yes
- Host Software Tinkerine Suite
- Slicer Integrated CuraEngine
- OS Mac, Windows
- Open Software? No
- Open Hardware? No

BACK FOR A SECOND YEAR, VANCOUVER'S TINKERINE STUDIOS HAS ADDED

a shiny new printer to their lineup, the Ditto Pro. We put the bright white machine through its paces and found that there's a lot to like.

UNIQUE OPEN C FRAME

Keeping with the open design of their previous Ditto and Litto models, the new Pro has a very accessible "open C frame" build area. It's great for demonstrations, as onlookers can easily see how it works. Fashioned from white Dibond panels, it features bright LED lighting and a built-in graphical LCD screen with an SD card slot. The extruder hot end is well designed, and the filament loading and changing was easy following the on-screen prompts.

The Ditto Pro is one of the few systems where the filament spool is kept within the confines of the printer. It's a small detail, but a game changer when you're pressed for space.

FOURTH HIGHEST IN OVERALL PRINT QUALITY

This machine scored the fourth highest overall print quality in our tests, with especially impressive performance in the Overhang and Surface Finish tests. The Ditto Pro's build area of 215×160×205mm falls just below average size, and it comes equipped with a removable, unheated, glass build plate, making this machine PLA only. Leveling the build plate was easy using the on-screen direction and the three-point adjustment knobs, but our testers had problems with print adhesion until we began using glue sticks.

INTUITIVE BESPOKE SOFTWARE

Tinkerine supplies their own bespoke software for their printers, known as Tinkerine Suite. It provides a user-friendly interface while tucking away the more technical details, and uses Ultimaker's open-source Cura engine under the hood. Many of our testers found the software to be intuitive and easy to use. There's no provision for manually controlling the printer from the

software, but it's an available option in the LCD menus.

LACKING DETAILED DOCUMENTATION

One of the biggest improvements across the field of tested printers this year has been in the area of documentation; unfortunately this has not been the case for the Ditto Pro. The primary machine documentation for this model was a nicely designed, but extremely brief, quick-start guide and an 18-page Tinkerine Suite software bound 50-100 page guides, supplying so little in the way of documentation is a significant shortcoming.

The FAQ section on the Tinkerine website covers some topics such as print adhesion, but it doesn't offer concrete direction, instead suggesting only that something may be needed. Similarly, the FAQ suggests that in certain circumstances the stepper driver voltage may need to be tuned, but offers no direction about what the process entails or how to go about it.

CONTROL ISSUES

Throughout the course of our testing, the Ditto Pro performed extremely well, and did not experience any jams or clogs. However, testers consistently reported that the LCD control panel knob was way too sensitive, often making it hard to select the correct item from the menu. This ranged from a nuisance to borderline unusable throughout the weekend and was a source of frustration for many testers.

CONCLUSION

The Ditto Pro is a great-looking machine with print performance to match. It scored as well as some of the best printers we tested, while far less expensive than most of them. If the documentation were improved significantly, we believe that the combination of good design and easy to use software would make it ideal for new users. As it stands, the Ditto Pro is probably best for the user willing to get a little more involved in the care and feeding of the system — a tinkerer, and maybe that's the point. 🍌

WE PUT THE BRIGHT WHITE MACHINE THROUGH ITS PACES AND FOUND THAT THERE'S A LOT TO LIKE.

PRINT SCORES

● Accuracy	1	2	3	4	5
● Backlash	1	2	3	4	5
● Bridging	1	2	3	4	5
● Overhangs	1	2	3	4	5
● Fine Features	1	2	3	4	5
● Surface Curved	1	2	3	4	5
● Surface General	1	2	3	4	5
● Tolerance	1	2	3	4	5
● XY Resonance	FAIL	PASS			
● Z Resonance	FAIL	PASS			

PRO TIPS

To get your prints to stick to the platform, cover it with blue tape or use a glue stick.

WHY TO BUY

Simplified software (but configurable settings) that produces great prints with nice Surface Finish and solid Overhangs. The Ditto Pro takes G-code, so you can use whatever slicer you like.

How'd it print?



JOHN ABELLA is a maker of things, obsessive hobbyist, 3D printing and CNC enthusiast. Maker Faire New York 3D Printer Village wrangler and lead instructor at BotBuilder.net. John has written for all three Make: 3D printer guides.

BEE THE FIRST

Smartly designed consumer-grade hardware, with a little something extra

WRITTEN BY CHRIS YOHE & ANNA KAZIUNAS FRANCE

BeeTheFirst | beeverycreative.com

- Price as Tested \$2,172
- Build Volume 190x135x125mm
- Bed Style Unheated acrylic
- Temperature Control No
- Materials BeeTheFirst PLA only
- Print Untethered? Unplug USB, wi-fi via BeeConnect
- Onboard Controls? No
- Host Software BeeSoft
- Slicer Integrated CuraEngine
- OS Mac, Windows, Linux
- Open Software? BeeSoft GPL v2.0, BeeTheFirst firmware GPL v3.0
- Open Hardware? No

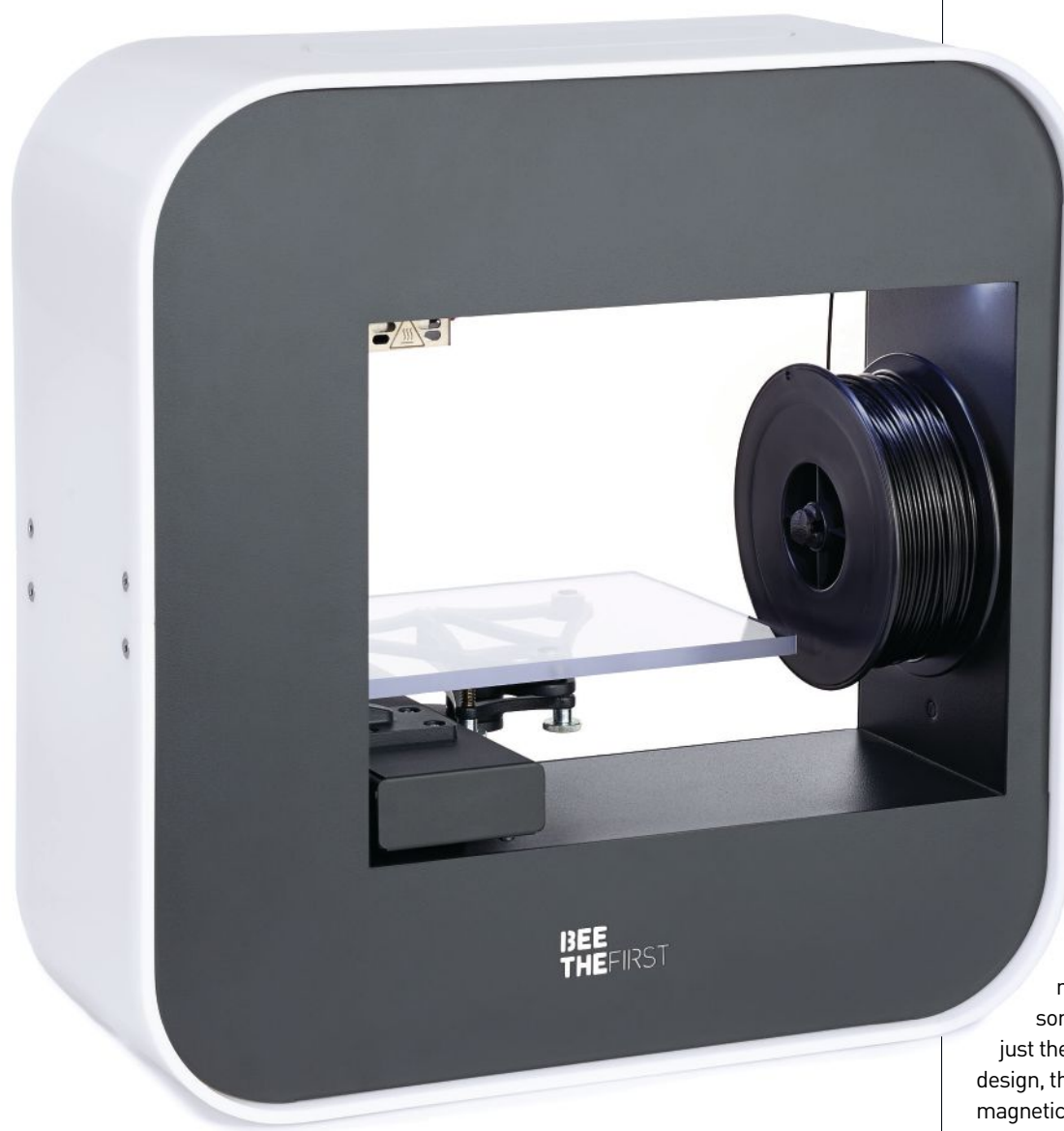

LOOKING FOR A TRULY CONSUMER-GRADE PRINTER THAT INTEGRATES LOOKS AND PORTABILITY WITH SMART DESIGN? You'll find it in BeeTheFirst. Portugal's BeeVery-Creative provides a fantastic out-of-the-box experience that allows anyone to painlessly enter the world of desktop 3D printing. Neophytes will be up and running quickly and this portable, polished machine is sure to look great on any desk or coffee table, but even seasoned veterans will find some interesting software Easter eggs if they peek below the shiny surface.

BEAUTY AND BRAINS

Upon unboxing, it's immediately clear that this is something new. But it's not just the hip, modern, minimalist design, the clever built-in handle, or magnetically removable build plate that piqued our interest — we were impressed by the forward-thinking industrial and user-experience design.

Brian Kaldorf

OCCAM'S RAZOR

It's refreshing to see a machine that's been designed from the ground up with equal focus on aesthetics, ergonomics, user experience, and functionality. BeeTheFirst also defies the current trend of adding fancy extruder sensors and auto-levelers to solve common printer problems, instead applying the tenet of Occam's razor: Good design solves problems in the simplest way possible, instead of cramming in more tech.

The cleverly integrated, magnetic/kinematically coupled bed with large accessible knobs is hands down the easiest we have ever leveled. The thick acrylic build platform sits upon a sturdy metal arm, which unlike the flimsy plastic parts present on many desktop machines, will never warp or twist. We popped it off and on dozens of times throughout our testing without the need to re-level.

CLEAR BEGINNER DOCUMENTATION

The user guide is well written, brief, and surprisingly informative. It gives a concise breakdown of the machine and clearly sets new-user expectations. There are also numerous troubleshooting videos on BeeVeryCreative's site, including how to take apart the case (it's easier than it looks) to clear a jammed extruder.

MATERIALS MATTER

Another interesting design feature is the tiny, magnetically attached internal spool that holds proprietary (but unchipped) filament. Like Afinia, BeeVeryCreative seeks to eliminate nozzle jamming by operating at higher temperatures of about 220°C. We fed ours non-OEM orange Ultimachine which produced part of a very stringy print before jamming completely. BeeVeryCreative materials have been limited to eight colors of PLA, but recent software update options reveal that more are on the way soon.

STRAIGHTFORWARD SOFTWARE, NO ADVANCED SETTINGS

When it comes to printing, they couldn't have made it simpler. The custom BeeSoft host software has all of the standard placement, scaling, and rotation options, but the print dialog deliberately restricts layer height and infill to a few simple choices in order to streamline the experience. BeeSoft is in active development and provides both regular and beta releases frequently. Since the Shootout, the low (0.3mm) and high (0.1mm) slicing options have been expanded to include a 0.05mm setting and additional infill density options, plus the ability to print untethered after kicking off a print via USB.

Shootout prints run at 0.1mm ranked within the top third of printers tested. This machine also had very little Backlash, but had some trouble with Fine Features and scored poorly on the Tolerance test.

EASTER EGGS!

Hardcore enthusiasts don't despair! While not advertised, there are plenty of software hacking opportunities under the hood. Here's where it gets interesting: BeeSoft's interface is derived from ReplicatorG and slices with CuraEngine. Both BeeSoft and the BeeTheFirst firmware are completely open-source and GPL-licensed: point your browser to github.com/beeverycreative and clone away!

They've also forked OctoPrint and created their own BeeTF variant of OctoPi that works with the BeeTF's speedy R2C2 printer controller (ARM 32bits running at 100MHz) over USB native. They plan to offer their own BeeConnect Raspberry Pi kit, followed by assembled versions and mobile apps.

CONCLUSION

With hand-holding for beginners and a GitHub repo full of open-source software for advanced users, BeeTheFirst has something for everyone. 🍯

WITH HAND-HOLDING FOR BEGINNERS AND A GITHUB REPO FULL OF OPEN-SOURCE SOFTWARE FOR ADVANCED USERS, BEETHEFIRST HAS SOMETHING FOR EVERYONE.

PRINT SCORES

● Accuracy	1	2	3	4	5
● Backlash	1	2	3	4	5
● Bridging	1	2	3	4	5
● Overhangs	1	2	3	4	5
● Fine Features	1	2	3	4	5
● Surface Curved	1	2	3	4	5
● Surface General	1	2	3	4	5
● Tolerance	1	2	3	4	5
● XY Resonance	FAIL	PASS			
● Z Resonance	FAIL	PASS			

PRO TIPS

- The BeeConnect software is continually updated and released in two parallel versions, one production, one beta. Check out the beta for the newest features.
- BeeTheFirst can print with Afinia's new PLA (green worked well for us)
- Want to print wirelessly? Grab a Raspberry Pi and check out "BeeConnect": github.com/beeverycreative

WHY TO BUY

An easy-to-use, attractive, portable machine with stripped-down, custom open-source software. Uses smart hardware design (instead of sensors) to make bed leveling easy.

How'd it print?



CHRIS YOHE Software developer by day, hardware hacker by night, Chris is a man of many gadgets. A member of HackPittsburgh, he is an avid 3D printing enthusiast and like many others is amassing a slowly growing army of manufacturing minions. From rugby, to tailgating, to 3D printing he's always looking for an excuse to make the world a better, or at least more interesting, place.

TYPE A 2014 SERIES 1

Integrated OctoPrint, but needs fine-tuning

WRITTEN BY MATT GRIFFIN



2014 SERIES 1 | typeamachines.com

- Price as Tested \$2,749
- Build Volume 305×305×305mm
- Bed Style Unheated glass
- Temperature Control? Yes
- Materials PLA
- Print Untethered? Preconfigured OctoPrint
- Onboard Controls? Limited
- Host Software Cura for Type A Machines
- Slicer Integrated CuraEngine
- OS Mac, Windows, Linux
- Open Software? Type A Cura: source released, license unknown
- Open Hardware? Auxiliary design files, license unknown

TYPE A MACHINES' 2014 SERIES 1 EDITION IS ITS FIRST SLEEK, TOOLED, powder-coated aluminum and acrylic paneled printer with the largest build volume (one cubic foot!) of any printer we reviewed.

EASY SETUP, MINIMALISTIC CONTROLS

Type A Machines invested considerable attention in crafting the documentation and unboxing experience. As a result—from setup to first prints—prepping the 2014 Series 1 was a piece of cake, one of the easiest setups I experienced in the Shootout. Physical interface elements are minimal, consisting of a handy glowing “machine halt” button and two knobs for manual platform adjustments (one raises/lowers the platform, the other fine tunes “Z-height”—a nice touch!).

INTEGRATED WIRELESS PRINTING

The Type A-branded out-of-the-box OctoPrint integration proved to be my favorite new feature. I was able to prep, monitor, and even pause the machine on my laptop from across the room while spending time servicing other printers. I had no issues setting up OctoPrint for wireless browser access, but a few testers had a harder time and walked away from this experience frustrated. There

are a few “gotchas” along the way if you skim the Quick Start Guide too quickly.

“LOOKS FAST, BUT HOW'S THE RIDE?”

As one of the testers said wistfully, “a machine looking like this should print better.” The 2014 Series 1 delivered on ease of setup and operation, but in our Shootout weekend did not deliver the print quality to match comparably priced machines or meet the expectations established by the design-forward new printer body.

Sometimes the extruder would begin to underextrude, laying down wispy, brittle material—a sign of stripped filament, an overheated feeder, or a clogged nozzle. Also, the extruder fan, necessary for printing PLA, seemed to be poorly placed and directed. Studying the prints afterward, we could tell which side of the objects faced the extruder fan and which didn't, which seemed odd.

CONCLUSION

Type A has integrated a number of clever and well-implemented machine design and software toolchain improvements into the Type A 2014 Series 1. Overall, printing was easy and consistent, but we weren't as impressed as we had hoped to be given the ambitious resets and “tested and tuned in our factory” promise. 🍷

PRINT SCORES

● Accuracy	1	2	3	4	5
● Backlash	1	2	3	4	5
● Bridging	1	2	3	4	5
● Overhangs	1	2	3	4	5
● Fine Features	1	2	3	4	5
● Surface Curved	1	2	3	4	5
● Surface General	1	2	3	4	5
● Tolerance	1	2	3	4	5
● XY Resonance	FAIL	PASS			
● Z Resonance	FAIL	PASS			

PRO TIPS

- To print a broad range of materials, you'll need to add a fan shroud for active cooling or a flexible filament guide.
- Windows users, pay close attention to setup instructions, don't skip the browser plugin for Chrome, or you will have difficulty connecting.

WHY TO BUY

Fully implemented and skinned OctoPrint hardware/software for immediate networked printing. In addition to Cura, you can now print to the Type A directly from Meshmixer, Autodesk's model repair and support creation software.

How'd it print?



MATT GRIFFIN is director of community & support at Adafruit Industries, a former MakerBot community manager, and author of the forthcoming book, *Design and Modeling for 3D Printing* (Maker Media). He can be seen weekly on Adafruit's “3D Hangouts” live video series, and glimpses of his adventures in the early days of desktop 3D printing are tucked into the corners of the Netflix original documentary, *Print the Legend*.

AFINIA H480

WRITTEN BY JOSH AJIMA

Excellent out-of-the-box experience, great for educators



AFINIA H480 | Afinia.com

- **Price as Tested** \$1,299
- **Build Volume** 140×140×135mm
- **Bed Style** Heated perf board
- **Temperature Control?** No
- **Materials** Afinia PLA, ABS
- **Print Untethered?** Unplug USB
- **Onboard controls?** No
- **Software** Afinia 3D
- **Slicer** Afinia 3D
- **OS** Mac, Windows
- **Open Software?** No
- **Open Hardware?** No

Available at MakerShed bit.ly/Alfina-H480

AFINIA CONTINUES TO LIVE UP TO ITS “EASY TO USE” REPUTATION WITH THEIR UPDATED H-SERIES PRINTER. The H480 printer may appear identical to the previous model, but it now includes automatic platform leveling and nozzle height detection.

AUTOMATIC CALIBRATION

Leveling a print bed and setting the extruder height are two of the biggest challenges for beginners. The Afinia H480 uses a magnetically attached sensor to perform automatic platform level calibration. A sensor attached to the extruder probes the bed at 9 different points and a separate sensor determines the correct nozzle height. Even experienced users may be surprised at how reliable prints are when these important calibration steps are automated.

SIMPLE SETUP, GREAT PRINT SURFACES

The Afinia software is easy to use, providing all the essentials for slicing and printer control in an uncluttered interface. The software defaults create rafts and supports which, combined with the heated bed, gives great print results, although the built-in slicer didn't fare well with very small positive Fine Features or Bridging. It excels at producing high-quality Surface Finish and did well with the articulated robot Toler-

ances. Other printers may have flashier interfaces or larger build volumes, but the Afinia's Surface Finish and ease of use keeps it in the top 10.

NOW WITH (PROPRIETARY) PLA

The Afinia (and its Up brethren) lack user-controlled temperature settings and print ABS at a much higher temp (260°) than other printers. This requires Afinia-produced high-temperature filament to perform properly. Afinia has also begun to produce its own brand of specially formulated PLA, but color selection is (at press time) limited. It's not recommended to use non-Afinia/Up filaments with this machine.

NOT FOR TINKERERS

The same features that make the H-Series a top “Just Hit Print” choice will steer hardware hackers away. The closed design means that there are limited options to tweak or tinker with the machine. The Afinia software only allows limited choices for layer height, temperature and percent infill.

CONCLUSION

Overall, the updated Afinia H480 offers a reliable print experience that should appeal to the growing ranks of new 3D printer users. 🍌

PRINT SCORES

● Accuracy	1	2	3	4	5
● Backlash	1	2	3	4	5
● Bridging	1	2	3	4	5
● Overhangs	1	2	3	4	5
● Fine Features	1	2	3	4	5
● Surface Curved	1	2	3	4	5
● Surface General	1	2	3	4	5
● Tolerance	1	2	3	4	5
● XY Resonance	FAIL	PASS			
● Z Resonance	FAIL	PASS			

PRO TIPS

- Load models and configure settings while preheating to save time.
- Use BuildTak to eliminate perforated print bottoms.
- You can't turn off support completely, but you can minimize the support angle to 10° to eliminate most support structures. Use “Print Setup” menu (3D Print menu > setup)

WHY TO BUY

Great surface finish with “fine” print settings. Automatic platform leveling and nozzle height detection remove beginner frustration. Good for educators, as reliable design and easy-to-use software mean successful prints with less training and support issues. Includes a 1-year manufacturer's warranty, with an optional 1-year extension. Includes accessories kit.

How'd it print?



JOSH AJIMA is a high school technology resource teacher and a K12 makerspace and 3D printing advocate. He created the Makerspace Starter Kit, runs a STEM camp makerspace, and sponsors a 3D printing club. designmaketeach.com

FELIX 3.0

Nice surface finish, but tinkering required

WRITTEN BY MATT STULTZ & YVES SINNER



Available at [Maker Shed](https://www.makershed.com) bit.ly/Felix-3

LAST YEAR THE FELIX 2.0 WAS OUR “SURPRISE HIT.” THIS YEAR’S MODEL, the fully assembled Felix 3.0 (also available as a kit) has been upgraded with injection-molded parts and a dual-extrusion option, but it retains its portability, minimalist feel, and excellent print surfaces.

This machine doesn’t ship with a printed manual, but their site provides a well-illustrated setup guide and configuration files for KISSlicer and SFACT. The tiny bed-leveling nuts are hard to access, but we liked the Felix’s two-part leveling and filament management systems.

There were some major issues: Our prints were offsetting/shifting to the side. Felix support said to tighten the belts, but the support forums diagnosis was improperly adjusted, overheating stepper drivers. Without the proper tools on hand we opted for an active cooling solution. Opening the electronics case and positioning a fan across the stepper drivers enabled us to complete our test prints. 🍷

PRINT SCORES

Accuracy	2	3	4	5	
Backlash	1	2	3	4	5
Bridging	1	2	3	4	5
Overhangs	1	2	3	4	5
Fine Features	1	2	3	4	5
Surface Curved	1	2	3	4	5
Surface General	1	2	3	4	5
Tolerance	1	2	3	4	5
XY Resonance	FAIL	PASS			
Z Resonance	FAIL	PASS			

PRO TIPS

Fix offset prints by adjusting the stepper drivers with a nonconductive screwdriver and multimeter, or use active cooling.

WHY TO BUY

Portability, large print bed, dual-extrusion capability, and continued upgrade-ability: A Felix 1.0 can be upgraded to a Felix 3.0.

felix 3.0 | [felixusaprinters.com](https://www.felixusaprinters.com)

- Price as Tested \$2,012 (assembled dual extrusion)
- Build Volume 255×205×235mm
- Bed Style Heated
- Temperature Control? Yes
- Materials PLA, ABS, Armitel
- Print Untethered? Yes
- Onboard controls? SD card
- Host Software Repetier-Host
- Slicer SFACT/KISSlicer
- OS Mac, Windows, Linux
- Open Software? Third-party software
- Open Hardware? No

DEEGREEN

Quiet, with very reliable automatic bed leveling

WRITTEN BY ERIC CHU



WITH AN ALL-METAL FRAME WRAPPED UP IN CLEAN ALUMINUM-POLYMER sheets, be3D’s fully enclosed DeeGreen is a consumer-centric printer with a touchscreen and fully automatic bed leveling (its best feature).

Each print starts with the servo-actuated, limit-switch sensor swinging down. The pointed tip on the sensor touches numerous spots on the glass build plate, then swings back up and the print begins with an extruder-priming bed wipe.

The auto-leveling was extremely reliable throughout the testing, but the unheated, removable, magnetic glass platform needs preprint glue stick application. Postprint, that glue can also make removal tough.

Although the printer uses premium materials, our review unit’s touchscreen was falling into the machine, and one of the acrylic windows fell off. Print quality was at the low end of printers tested, but it was one of just five printers to pass both mechanical tests. 🍷

PRINT SCORES

Accuracy	1	2	3	4	5
Backlash	1	2	3	4	5
Bridging	1	2	3	4	5
Overhangs	1	2	3	4	5
Fine Features	1	2	3	4	5
Surface Curved	1	2	3	4	5
Surface General	1	2	3	4	5
Tolerance	1	2	3	4	5
XY Resonance	FAIL	PASS			
Z Resonance	FAIL	PASS			

PRO TIPS

For every print, clean the build plate and reapply glue stick, remove with scraper

WHY TO BUY

Automatic bed leveling, quiet enclosed build area, autostop safety features

DeeGreen | [be3d.cz](https://www.be3d.cz)

- Price as Tested \$2,025
- Build Volume 150x150x150mm
- Bed Style Unheated glass
- Temperature Control? No
- Materials PLA, PVA
- Print Untethered? SD Card, unplug USB
- Onboard controls? Yes
- Host Software DeeControl
- Slicer DeeControl integrated CuraEngine
- OS Mac, Windows
- Open Software? No
- Open Hardware? No

ZORTRAX M200

Unique case and lots of extras WRITTEN BY NICK PARKS



ZORTRAX M200 | zortrax.com

- Price as Tested \$1,990
- Build Volume 200×200×185mm
- Bed Style Heated perf board
- Temperature Control? No
- Materials ABS
- Print Untethered? SD card
- Onboard controls? Yes
- Host Software Z-Suite
- Slicer Z-Suite
- OS Mac, Windows
- Open Software? No
- Open Hardware? No

THE ZORTRAX M200 COMBINES SUPERB PRINT QUALITY WITH A LARGE BUILD VOLUME, a built-in screen and SD card reader for untethered printing, and requires almost no maintenance. This machine comes with a large variety of useful extras including a complete hot end, two extra nozzles, and a toolkit that includes everything required for maintaining the machine.

ALL-ALUMINUM EXTERIOR, UNIQUE 8-ROD GANTRY

The build quality of this machine is absolutely amazing. The M200 is made entirely of aluminum, which allows the machine to be both light and rigid. It also has a unique gantry setup that uses four X-axis and four Y-axis rods, which also increases the machine's rigidity.

The Zortrax doesn't have auto leveling, instead the bed is equipped with five conductive squares that the M200 uses to level the bed and calibrate the nozzle height, prompting the user to either tighten or loosen the bed-leveling adjustment knobs. These features, coupled with the perforated board, allow the prints to maintain strong adhesion to the bed while printing.

NO TEMP CONTROL, ABS ONLY

The Zortrax software does not allow for user temperature control and is built for printing in ABS only. I've always found ABS to be smelly, warp-prone, and generally difficult to work with, but the M200 does a great job of preventing warping by using a perforated bed and raft system that holds the prints down tight.

Zortrax makes two lines of filament, Z-ABS and Z-ULTRAT, both of which are formulated to work well on the M200. The Z-ABS is just standard ABS filament that works well and costs only \$20. The Z-ULTRAT has a high hardness and low elasticity level of deformation, but costs \$50. We ran the test prints in Ultimachine ABS, which yielded beautiful prints, but I found that support material wasn't as easy to remove as it was when using the filaments designed for the machine.

CONCLUSION

I recommend the Zortrax M200 to anyone looking for a machine that can print large, precise, and durable prints without requiring a lot of time to fiddle with settings or breaking the bank. 🚫

PRINT SCORES

● Accuracy	1	2	3	4	5
● Backlash	1	2	3	4	5
● Bridging	1	2	3	4	5
● Overhangs	1	2	3	4	5
● Fine Features	1	2	3	4	5
● Surface Curved	1	2	3	4	5
● Surface General	1	2	3	4	5
● Tolerance	1	2	3	4	5
● XY Resonance	FAIL	PASS			
● Z Resonance	FAIL	PASS			

PRO TIPS

● Zortrax owners get reduced prices on filament, lowering each 1Kg spool of standard filament to \$19.99.

WHY TO BUY

Auto calibration, easy-to-use software. Great for workplaces where quality, reliability, and ease of use are highly important. An excellent choice for people who need the durability of ABS without all of the warping and frustration.

How'd it print?



NICK PARKS is an engineering intern at *Make: Labs* and is studying mechanical engineering at Santa Rosa Junior College. He likes to build and take apart things to make products better or create something new. He enjoys working at *Make: magazine* and likes to help other people build projects of their own.

DA VINCI

WRITTEN BY MICHAEL CURRY

Even China couldn't build a 3D printer this cheap



DA VINCI | xyzprinting.com

- Price as Tested \$499
- Build Volume 200×200×200mm
- Bed Style Heated glass
- Temperature Control? No
- Materials XYZprinting ABS filament cartridges
- Print Untethered? No
- Onboard Controls? Limited
- Host Software XYZWare
- Slicer XYZWare
- OS Mac, Windows
- Open Software? No
- Open Hardware? No

Brian Kaldorf

AT \$499, THE DA VINCI 1.0 BY XYZ PRINTING IS CURRENTLY THE BEST-SELLING PRINTER ON AMAZON. It's made in Thailand, an important distinction, because I'm certain even China couldn't build a 3D printer this inexpensive. The da Vinci's spec sheet boasts features previously seen only on other company's flagship models: an enclosed build volume, heated glass build plate, LCD Screen, assisted leveling, integrated nozzle cleaner, and front panel controls (although they are for changing filament and bed leveling only, not untethered printing). It's packaged like a consumer product (no exposed wires) and the build volume is neatly enclosed behind translucent plastic. We tested the single extrusion version, but a dual has recently become available.

MICROCHIPPED, PROPRIETARY PLASTIC

Our package clearly had some serious international miles on it, but everything was well packed and in good order. Inside the box was a quick-start guide, basic toolkit, and one proprietary microchip-embedded cartridge of ABS filament (a 600g cartridge is \$28, limited colors). Setup was easy, and the instructions for loading the filament are printed on the inside of the machine's top cover.

PRINT LIKE IT'S 2010

XYZ's software is geared toward novice users with intuitive controls, but the software has some quirks. Workflow is exclusively one-way. Once a model is sliced it cannot be adjusted — change anything and you'll have to reload and start over. The software's most glaring shortcoming is its slicer, which feels like an early prototype, indifferently laying down plastic with little regard to geometric conditions or input settings. Basic settings like layer height and infill didn't seem to have any effect on the printed result.

The da Vinci's print quality is roughly on par with what you would have seen from a kit-built machine in 2010. Its scores were consistently low in every category we tested. The immature slicing engine and low-quality gantry system make it difficult for the da Vinci to produce prints with fine detail or dimensional accuracy.

CONCLUSION

The da Vinci looks and prints exactly like the inexpensive consumer product it is. This is the disposable inkjet of 3D printing. It's a cheap, (mostly) easy-to-use option for hobbyists and younger students. ●

PRINT SCORES

● Accuracy	2	3	4	5	
● Backlash	1	2	3	4	5
● Bridging	2	3	4	5	
● Overhangs	1	2	3	4	5
● Fine Features	1	2	3	4	5
● Surface Curved	1	2	3	4	5
● Surface General	1	2	3	4	5
● Tolerance	1	2	3	4	5
● XY Resonance	FAIL	PASS			
● Z Resonance	FAIL	PASS			

PRO TIPS

- Avoid playing with the leveling system, it's easier to turn off the machine and level the platform by hand.
- The printer's low price has inspired a community of hardware hackers who are modifying the machines, search for their tips and see makezine.com/da-vinci

WHY TO BUY

It's cheap, fully enclosed, and a good value (price versus build volume). There's an SD card and filament hack possible for those who want to tinker.

THE DA VINCI PRINTS EXACTLY LIKE THE INEXPENSIVE CONSUMER PRODUCT IT IS.

How'd it print?



MICHAEL CURRY is an independent designer and researcher from Kansas City. skimba.com

AIRWOLF HD, HDx AND HD2x

Big volume, bigger price tag

WRITTEN BY
MICHEL SINNER



AIRWOLF | airwolf3d.com

- **Price as Tested** HD2x: \$3,995; HDx: \$3,495; HD: \$2,995
- **Build Volume** HD/HDx: 300×200×300mm, HD2x: 280×200×300mm
- **Bed Style** Heated glass
- **Temperature Control?** Yes
- **Materials** PLA, ABS, nylon, polycarbonate, PVA, and more
- **Print Untethered?** MicroSD Card
- **Onboard controls?** Yes
- **Host Software** MatterControl/ Cura/Repetier-Host
- **Slicer** CuraEngine / Slic3r
- **OS** Mac, Windows, Linux
- **Open Software?** Third-party software
- **Open Hardware?** No

THE AW3D HD, HDx, AND HD2x ARE THE LATEST ADDITIONS TO AIRWOLF 3D's ever-growing printer portfolio, clearly targeted at buyers with (very) deep pockets looking to print big in a wide variety of materials.

HIGH TEMP HOT END

Thanks to Airwolf 3D's new proprietary JRx hot end with a 0.5mm nozzle, the HDx and HD2x are not only capable of printing at temperatures up to 320°C but also with a vast array of materials including PLA, ABS, nylon, HIPS, and polycarbonate (for the HD, maximum temperature is only 260°C, so Airwolf 3D recommends to refrain from using nylon/PC). They also have a massive build volume of 18,000 cm³ (only the Type A and TAZ are larger). However, these features come with a hefty price tag, making the Airwolf machines the most expensive FFF machines we tested.

With an external footprint of 610×445×460mm, the first thing you'll need for these behemoths is lots of dedicated space and a sturdy desk or workbench. Airwolf now uses clear, 6mm-thick acrylic enclosures, which contributes to the printers' sturdiness, but brings the weight up to a whopping 40 pounds, rendering portability close to zero. Setting up these machines is easy due to clear and well-illustrated documentation. The initial

calibration guide makes bed leveling a breeze, but loading/unloading the filament can prove tricky.

SOLIDLY BUILT, BUT SOME MAJOR FLAWS

The HDx's overall print quality was in the lower middle of the pack (its siblings were near the bottom) and didn't fare well on Overhangs, Bridging, or Surface Finish. However, all models scored well on the mechanical tests (XY, Z Resonance) and Backlash tests, a testament to its sturdy, well-constructed frame. Additionally, users with big fingers will undoubtedly have problems using the VIKI front panel wheel and its microSD slot; both can be extremely fiddly. The HDx also integrates many 3D-printed parts: the joints between the acrylic panels, the spool holders, the top of the hot end, the extruder, etc.

CONCLUSION

The AW3D HD line — with their remarkable heated glass print bed (PET coated), their large print volume, high-temp nozzles, and beefy frames — have a lot going for them. However, the below-average print quality and the absence of premium features like auto bed leveling, a magnetically fixed glass bed (instead of binder clips), onboard cameras, and wi-fi connectivity doesn't justify their exorbitant price tags. ❌

PRINT SCORES

HD

● Accuracy	1 2 3 4 5
● Backlash	1 2 3 4 5
● Bridging	2 3 4 5
● Overhangs	2 3 4 5
● Fine Features	1 2 3 4 5
● Surface Curved	1 2 3 4 5
● Surface General	1 2 3 4 5
● Tolerance	1 2 3 4 5
● XY Resonance	FAIL PASS
● Z Resonance	FAIL PASS

HDx

● Accuracy	1 2 3 4 5
● Backlash	1 2 3 4 5
● Bridging	1 2 3 4 5
● Overhangs	2 3 4 5
● Fine Features	1 2 3 4 5
● Surface Curved	2 3 4 5
● Surface General	1 2 3 4 5
● Tolerance	1 2 3 4 5
● XY Resonance	FAIL PASS
● Z Resonance	FAIL PASS

HD2x

● Accuracy	1 2 3 4 5
● Backlash	1 2 3 4 5
● Bridging	1 2 3 4 5
● Overhangs	2 3 4 5
● Fine Features	1 2 3 4 5
● Surface Curved	1 2 3 4 5
● Surface General	1 2 3 4 5
● Tolerance	1 2 3 4 5
● XY Resonance	FAIL PASS
● Z Resonance	FAIL PASS

PRO TIPS

Slicing with CuraEngine produced much faster prints than MatterControl with equal print quality.

WHY TO BUY

Sturdy frame, huge build volume, high-temp nozzles.



REPLICATOR 5TH GENERATION

“Feature-packed” is putting it mildly

WRITTEN BY JOHN ABELLA



REPLICATOR | makerbot.com

- Price as Tested \$2,899
- Build Volume 252×199×150mm
- Bed Style Unheated plastic
- Temperature Control? Yes
- Materials MakerBot PLA
- Print Untethered? USB Stick, wi-fi / networked app
- Onboard controls? Yes
- Host Software MakerBot Desktop
- Slicer MakerBot Slicer
- OS Mac, Windows, Linux
- Open Software? No
- Open Hardware? No

Available at [MakerShed](http://MakerShed.com) bit.ly/Replicator-5th

IT'S IMMEDIATELY OBVIOUS UPON UNPACKING THE MAKERBOT REPLICATOR

that substantial engineering resources went into this fifth-generation machine's consumer-focused hardware and software. It sports a large, bright, color LCD interface, mobile or PC app-controlled LAN / wi-fi printing, an internal print-watching camera and a magnetically attached, sensor-packed Smart Extruder. The onboard LCD interface was by far the most complex of all systems we tested. While printing, you can scroll through system status to see print progress, slicer settings used, a rendering of the finished piece, and even snap photos.

INTEGRATED 3DP ECOSYSTEM

The MakerBot Desktop software is easy to use and certainly the most comprehensive of all packages tested. In addition to allowing the user to prepare and print files, it has extensive integration with Thingiverse and MakerBot Digital Store. After login, designs the user has “liked” on Thingiverse or models purchased from the Digital Store are automatically populated in the software, allowing (almost) one-click printability.

SURFACE FINISH NEEDS WORK

The new Replicator's print quality was at the higher end, especially on the Overhangs, Tolerance, and Backlash. However, it

was near the bottom of the pack in our Fine Features testing. Testers also commented that the Surface Finish was a step down from the Replicator 2.

NOISY

Within the first few minutes of using the new Replicator we noticed that it's not a quiet machine. As testers came over to watch it in action, the first thing mentioned was always the noise; the Z-axis movements sounded particularly pained.

RAZORS VERSUS BLADES

Use of non-OEM filament on the 5th generation Replicator is aggressively discouraged through the inclusion of an internally mounted, unusually sized filament spool and will void the 6-month machine warranty. We voided ours with Ultimachine, and it printed without issue. While we didn't experience problems with the Smart Extruder, it's worth noting that it's not user-serviceable. When jams occur after the 90-day extruder warranty period expires, a \$175 replacement must be purchased.

CONCLUSION

Out of all the machines tested, the fifth-generation Replicator is the closest to a networked appliance. We just wish there was more for the maker in this 'bot. 🗯

PRINT SCORES

● Accuracy	1 2 3 4 5
● Backlash	1 2 3 4 5
● Bridging	1 2 3 4 5
● Overhangs	1 2 3 4 5
● Fine Features	1 2 3 4 5
● Surface Curved	1 2 3 4 5
● Surface General	1 2 3 4 5
● Tolerance	1 2 3 4 5
● XY Resonance	FAIL PASS
● Z Resonance	FAIL PASS

PRO TIPS

- Have piles of non-MakerBot PLA on standard spools? Use a lazy Susan for filament management.
- The software does not warn or prevent trying to print something larger than the build area of the system.

WHY TO BUY

Ideal for someone who doesn't want to get under the hood but wants a networked, app-integrated machine with all the bells and whistles and is willing to pay (and keep paying) a premium for it.

How'd it print?



JOHN ABELLA is a maker of things, obsessive hobbyist, 3D printing and CNC enthusiast. Maker Faire New York 3D Printer Village wrangler and lead instructor at BotBuider.net. John has written for all three Make: 3D printer guides.

PRINT-RITE COLIDO

This "clone" runs G-code

WRITTEN BY ERIC CHU



PRINT-RITE'S COLIDO 3D PRINTER IS A MAKERBOT REPLICATOR CLONE WITH A TWIST — it runs G-code instead of .x3g files — allowing for slicer interchangeability.

Print-Rite provided Slic3r profiles whose prints scored well on the Overhangs and Tolerance tests. The LCD interface allows adjusting settings on the fly — great for experimenting and fine-tuning.

It's a good machine for hackers to tinker with. It has a solid gantry with very little backlash and although it's single extrusion, it has a dual-extruder motor mount. The heated aluminum print bed is leveled with four wing nuts and comes with glass sheets that are held on with two binder clips. The extruder uses metal parts and has a spring-loaded bearing to tension the filament against the drive gear. Prints are great when printing with its included filament but I had jamming issues when printing with Ultimachine's PLA, and there is no active cooling fan. ❌

PRINT SCORES

Accuracy	2	3	4	5	
Backlash	1	2	3	4	5
Bridging	1	2	3	4	5
Overhangs	1	2	3	4	5
Fine Features	1	2	3	4	5
Surface Curved	1	2	3	4	5
Surface General	1	2	3	4	5
Tolerance	1	2	3	4	5
XY Resonance	FAIL	PASS			
Z Resonance	FAIL	PASS			

PRO TIPS

The leveling script doesn't work properly, level the bed by hand.

WHY TO BUY

Low-cost, tinkerer-friendly Replicator clone that runs G-code, has a glass build plate

PRINT-RITE COLIDO | www.union-tec.com

- Price as Tested \$799
- Build Volume 225×145×150mm
- Bed Style Heated aluminum, glass sheet
- Temperature Control? Yes
- Materials PLA, ABS
- Print Untethered? SD card, OctoPrint compatible
- Onboard controls? Yes
- Host Software Repetier-Host
- Slicer Slic3r
- OS Mac, Windows, Linux
- Open Software? Third-party software
- Open Hardware? No

POWERSPEC 3D PRO

Dual extrusion for under \$1,000

WRITTEN BY ERIC CHU

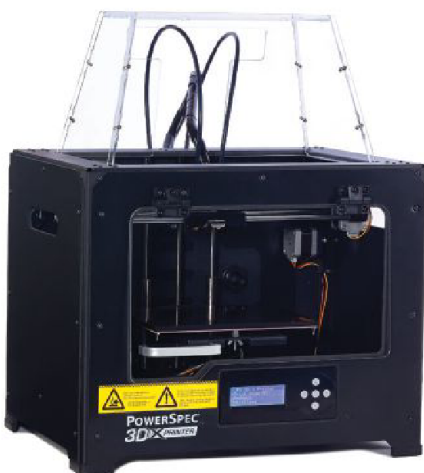

MICRO CENTER'S POWERSPEC 3D PRO IS ESSENTIALLY THE MAKERBOT ORIGINAL REPLICATOR (launched in early 2012, now retired), but it has a few design and materials improvements at half the price.

The black metal chassis of the printer is styled to mimic the Replicator 2X, but with hard composite boards with handle slots that cover the sides, with Replicator 2 style extruders. The directional buttons for onboard controls have been updated, providing tactile feedback when pressed. These details may seem minor, but they make the printer more enjoyable to use and easier to transport.

The included instructions step the user through setup of the outdated ReplicatorG, used with MakerBots until the release of MakerWare (with the painfully slow Skeinforge slicer). The 2X-style front lid doesn't fully close, leaving a bottom gap and instead of a single-piece vacuum-formed top cover, it is replaced by a user-assembled acrylic-sheet hood that feels a bit fragile. ❌

PRINT SCORES

Accuracy	1	2	3	4	5
Backlash	1	2	3	4	5
Bridging	1	2	3	4	5
Overhangs	1	2	3	4	5
Fine Features	1	2	3	4	5
Surface Curved	1	2	3	4	5
Surface General	1	2	3	4	5
Tolerance	1	2	3	4	5
XY Resonance	FAIL	PASS			
Z Resonance	FAIL	PASS			

PRO TIPS

Heat bed to 65°C for PLA. Print slowly. Use MakerBot Desktop instead of ReplicatorG. Check out Sailfish firmware.

WHY TO BUY

A dual extrusion machine based on a well-loved design that prints best in ABS.

PowerSpec 3D Pro | microcenter.com

- Price as Tested \$999.99
- Build Volume 226×144×149mm
- Bed Style Heated
- Temperature Control? Yes
- Materials PLA, ABS, PVA
- Print Untethered? SD Card
- Onboard controls? Yes
- Host Software ReplicatorG (MakerBot Desktop possible)
- Slicer Skeinforge (MakerBot Slicer possible)
- OS Mac, Windows, Linux
- Open Software? Third-party software
- Open Hardware? No

IDEA BUILDER

Dremel combines simplicity and low cost

WRITTEN BY TOM BURTONWOOD

IDEA BUILDER | dremel3d.com

- Price as Tested \$999
- Build Volume 230×150×140mm
- Bed Style Unheated acrylic, BuildTak surface provided
- Temperature Control No
- Materials Dremel PLA
- Print Untethered? SD card
- Onboard Controls? Yes
- Host Software Dremel 3D
- Slicer Dremel 3D
- OS Mac, Windows, Linux
- Open Software? No
- Open Hardware? No

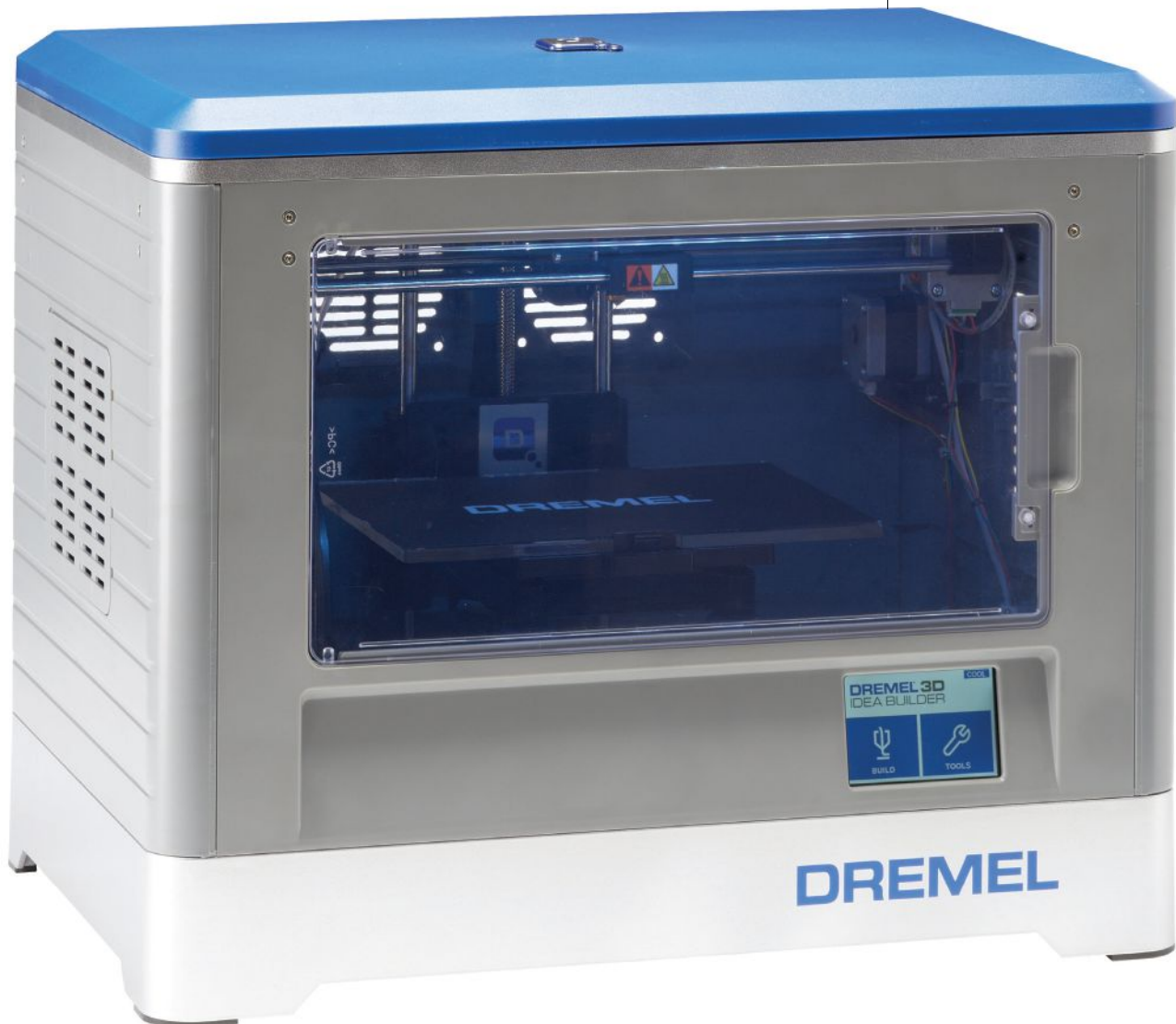

Clint Blowers

FROM THE EXTERIOR PACKAGING AND \$999 PRICE POINT, IT'S OBVIOUS that the Dremel Idea Builder is a product aimed squarely at the mass market. Their design team has clearly thought through the unboxing experience. Inside is a full-color, easy to follow, quick-start guide, two sheets of Dremel-branded BuildTak, and a printed instruction manual. As you would expect from a company like Dremel, their instruction manual is quite comprehensive and it's especially gratifying to see a glossary of terms to explain 3D printing to a new audience of makers.

Dremel has a long history of working with partners around the world to manufacture their tools and products, so it's no surprise to learn that the Idea Builder was conceived in partnership with China-based FlashForge, makers of the popular "Creator" Replicator clones. This model is based on the FlashForge Dreamer, whose electronics utilize the ARM Cortex-M4 CPU processor, instead of the ATmega chips used in the FlashForge Mightyboards.

ATTENTION TO DETAIL

With their entrance into 3DP, Dremel paid attention to the details. The Idea Builder has a color touch-screen interface that makes leveling the bed, loading filament, and selecting files a joy. This single-extruder machine feels solid, but lightweight. The sleek plastic exterior sports

chrome-like plastic trim, a detachable blue lid, two removable ventilation panels on each side, and a hinged, clear plexi front cover with a magnetic closure. The non-standard interior spool holder reduces the footprint and the large 3-point bed leveling knobs are easy to adjust.

NICE SOFTWARE, LIMITED SETTINGS

The Dremel 3D software interface is similar to MakerBot Desktop or Cura. It displays a 3D rendering of the build volume with options to move, rotate and scale parts, highlights model areas that need support, and shows a print preview. The speedy slicer has built-in high (0.1mm), medium (0.2mm) and low (0.3mm) resolution presets, but noticeably absent were options to change print temperatures, infill percentages, add rafts (without support), or use custom G-code profiles. There's also no heated platform, so this machine is PLA only.

CONCLUSION

The Idea Builder's attractive price point and features make it worth considering for a variety of user types. Although the software settings and materials choices are limited, Dremel has created a streamlined, consumer-ready user experience that will include free customer support delivered by "Dremel Experts" via phone, Skype, and email. 🍷

PRINT SCORES

● Accuracy	1	2	3	4	5
● Backlash	1	2	3	4	5
● Bridging	1	2	3	4	5
● Overhangs	1	2	3	4	5
● Fine Features	1	2	3	4	5
● Surface Curved	1	2	3	4	5
● Surface General	1	2	3	4	5
● Tolerance	1	2	3	4	5
● XY Resonance	FAIL	PASS			
● Z Resonance	FAIL	PASS			

PRO TIPS

Dremel recommends you use their PLA, but they aren't embedding microchips that require you to do so. The spool holder is a nonstandard size, so pick up a lazy Susan and feed the filament through the side vent to use your own.

WHY TO BUY

Attractive price point. For those who prioritize simplicity and ease of use over settings customization and materials choices.

WITH THEIR ENTRANCE INTO 3DP, DREMEL PAID ATTENTION TO THE DETAILS.

Why the Dremel Printer Matters

AT-HOME 3D PRINTING HAS GROWN PRETTY DARN QUICKLY, already generating hundreds of millions of dollars — estimated to quickly stretch into the billions — in revenue. Just six years since MakerBot made its prototype extruder head using ball point pens and a Dremel, the rotary tool maker and other established tool companies are now officially moving into this space. With them will come the benefits of decades of refined product development processes and customer support systems. Dremel's tried-and-tested focus on usability, along with its Wisconsin-based 24/7 call center, will be major draws for customers, particularly those new to 3D printing.

These new players will also bring

distribution clout. Over the last year we've seen various retailers, from Staples to RadioShack, experiment with 3D printers. But with Dremel's printer making a strong launch at Home Depot, to be followed by the massive network of other outlets that carry its products, this will quickly become one of the most visible 3D printers on the market.

The mainstream competition will push advancement of all areas of printing, while the open-source RepRap roots of 3D printing will challenge how these companies approach business. We'll see the machine turn from a gadget into a tool. And in the end, we think this will benefit everyone involved in 3D printing — especially the user. —Mike Senese

How'd it print?



TOM BURTONWOOD is an artist, educator, and entrepreneur based in Chicago, IL. He co-founded Mimesis, LLC, focusing on 3D scanning and digital fabrication. He teaches at The School

of the Art Institute of Chicago and Columbia College. tomburtonwood.com

DELTAMAKER

WRITTEN BY ANNA KAZIUNAS FRANCE

Simplify your workflow with this minimalistic deltabot



Brian Kaldorf

DeltaMaker | DeltaMaker.com

- **Price as Tested** \$2,399
- **Build Volume** 260mm Z, 240mm wide hexagonal platform
- **Bed Style** Unheated acrylic
- **Temperature Control?** Yes
- **Materials** PLA
- **Print Untethered?** Preconfigured OctoPrint
- **Onboard Controls?** No
- **Host Software** OctoPrint
- **Slicer** CuraEngine
- **OS** Mac, Windows, Linux
- **Open Software?** Third-party software
- **Open Hardware?** No

EVERYTHING ABOUT THE DELTAMAKER EXPERIENCE IS MINIMALISTIC AND SEAMLESS. With a Raspberry Pi tucked out of sight inside the base of its sleek silver frame, this wirelessly OctoPrint-controlled 'bot arrives completely assembled with onboard CuraEngine slicing. While not a new OctoPrint feature, this is the first commercial machine I've seen with it enabled (Type A ships without onboard slicing). I'm flabbergasted that other vendors haven't adopted it.

STREAMLINED SETUP

Setup consists of removing the machine from the securely packed box, placing the removable, magnetically attached acrylic build plate on the frame, and plugging it in. Skim the setup guide for the OctoPrint login info, autolevel, load filament, and start printing from the browser of any device.

PROPERLY PRECONFIGURED ONBOARD SLICING

The built-in slicing configuration is conservatively configured to ensure success. It's super easy and works quite well, as long as the model has been properly oriented before uploading. It's refreshing that, unlike many other vendors utilizing free software toolchains, DeltaMaker took the time to properly preconfigure their slicing

settings. The result is that their spartan approach makes the machine layer almost invisible, allowing OctoPrint to take center stage. Like any advanced digital fabrication tool – the hardware just works – and user energy is spent in software tweaking parameters, not mechanical fussing.

DOCUMENTATION DEFICIENCY, XY VIBRATION

One area where DeltaMaker's minimalist approach breaks down is the complete lack of readily available, online documentation. This austerity stands out in sharp contrast to the other machines tested. A second detraction is that the hollow-ball connector rod ends that join the arms to the extruder-mounted effector platform seem to rattle a bit. It's not particularly loud, especially when compared to Cartesian printers, but it appears to have produced resonance in the XY plane, failing our XY Resonance test.

CONCLUSION

While the DeltaMaker had miserable ratings for Retraction and Overhang, it earned top scores for Accuracy, Bridging, Backlash, Tolerance, and Z mechanical. It also produced a nicely surfaced, completely articulated robot, tying with the Zortrax for the fourth highest overall print-quality score. 🏆

PRINT SCORES

● Accuracy	1	2	3	4	5
● Backlash	1	2	3	4	5
● Bridging	1	2	3	4	5
● Overhangs	1	2	3	4	5
● Fine Features	1	2	3	4	5
● Surface Curved	1	2	3	4	5
● Surface General	1	2	3	4	5
● Tolerance	1	2	3	4	5
● XY Resonance	FAIL	PASS			
● Z Resonance	FAIL	PASS			

PRO TIPS

- Although currently without a heated-bed option, the Azteeg X3 controller used makes future upgrades possible.
- The Marlin firmware is slicer agnostic and both KISSlicer and Slic3r are viable options, but just use Cura. For more complex slicing needs, switch to the desktop version and upload your G-code via the browser.

WHY TO BUY

This delta robot-style machine looks and operates very differently than the boxy, Cartesian printers. It has a tall Z build area and ships with preconfigured OctoPrint with wi-fi enabled CuraEngine slicing out of the box.

How'd it print?



ANNA KAZIUNAS FRANCE is *Make* magazine's Digital Fabrication Editor. She's also Dean of the global Fab Academy program, co-author of *Getting Started with MakerBot*, compiled *Make: 3D Printing* and has organized and

directed the 3D Printer Shootout for the past two years. kaziunas.com

SEEMECNC ORION

Affordable delta arrives (mostly) preassembled, but requires some fine-tuning

WRITTEN BY MATT GRIFFIN



SeeMeCNC Orion | seemecnc.com

- **Price as Tested** \$1,200
- **Build Volume** 230mm Z, round 150mm diameter platform
- **Bed Style** Heated glass
- **Temperature Control?** Yes
- **Materials** PLA, ABS
- **Print Untethered?** SD card, OctoPrint compatible
- **Onboard controls?** Yes
- **Host Software** Repetier-Host
- **Slicer** Slic3r
- **OS** Mac, Windows, Linux
- **Open Software?** Third-party software
- **Open Hardware?** Auxiliary design files, license unknown

Available at [MakerShed](http://MakerShed.com) bit.ly/Orion-Delta

SEEMECNC'S SECOND DELTA PRINTER, THE ORION, SHIPS WITH AN ASSEMBLED frame and a low price that could go a long way to increase delta adoption in the maker community.

SETTING UP THE ORION

The Orion arrives (mostly) preassembled with the Cheapskate carriages, delta arms, and EZStruder bowden extruder already connected to the towers, a tremendous relief for those who have studied the early delta printer kits. The online manual clearly guides you through plugging in electronics, LCD interface, and power supply.

Unlike a few recent deltabots, there's no autoleveler — you must calibrate the Z-height manually. The correct height for printing the first layers is determined by measuring down from the Z-axis endstop at the top of the machine, so time spent tuning this carefully will be rewarded later.

WOBBLES AND ECCENTRICITIES

One of the Orion's handiest features is the Cheapskate carriage. The "eccentric cams" on each carriage can be rotated to tighten or loosen their grip on the aluminum extrusion tracks. After a few unusually low-quality prints, we discovered that one of these carriages was loose. After tightening,

we reran all of the parts again.

Shootout prints were run using the vendor's recommended host and slicing software, but the Slic3r-prepared test probes proved problematic. It scored poorly on almost all tests, even after the prints were rerun. Exceptions include high marks on the difficult Overhangs probe and a "pass" on both the mechanical XY and Z Resonance tests.

SLOW DOWN AND USE CURA

After tallying our test data, we noticed that the Orion's provided profiles were WAY too fast — over twice the speed of any other machine tested. Experienced Orion users report that their results have been superior using Cura with their own settings rather than the provided Slic3r profiles. Fellow tester Matt Stultz reports that the Orion is his go-to production machine and advises new users to use Cura from the start.

CONCLUSION

Although this printer did not perform well during our testing, makers who slow down their print speed, use Cura, and spend the time upfront to carefully fine-tune the Cheapskate carriages' Z-height should be pleasantly surprised with the performance of this affordable delta. 🍀

PRINT SCORES

● Accuracy	1	2	3	4	5
● Backlash	1	2	3	4	5
● Bridging	1	2	3	4	5
● Overhangs	1	2	3	4	5
● Fine Features	1	2	3	4	5
● Surface Curved	1	2	3	4	5
● Surface General	1	2	3	4	5
● Tolerance	1	2	3	4	5
● XY Resonance	FAIL	PASS			
● Z Resonance	FAIL	PASS			

PRO TIPS

- The cancelation option on the LCD interface isn't quickly accessible. To halt in a hurry, hit the button under the main control knob.
- Take the time to fine-tune the Z-height by turning the screw head protruding from the top of each carriage. When homing preprint, the screws make contact with the endstops; fine-tuning each of these (to 0.1mm or less!) takes serious time — and the resulting changes in the path of the nozzle across the build area can be difficult to evaluate.

WHY TO BUY

Low cost deltabot, handy onboard LCD interface, unusual design is fun to watch.

How'd it print?

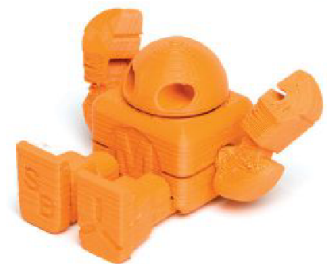

MATT GRIFFIN is Director of Community & Support at Adafruit Industries, a former MakerBot community manager, and author of the forthcoming book *Design and Modeling for 3D Printing* (Maker Media). He can be seen

weekly on Adafruit's "3D Hangouts" live video series, and glimpses of his adventures in the early days of desktop 3D printing are tucked into the corners of the Netflix original documentary *Print the Legend*.

ULTIMAKER ORIGINAL+

Same great kit, now with a heated glass bed

WRITTEN BY YVES SINNER & NICK PARKS

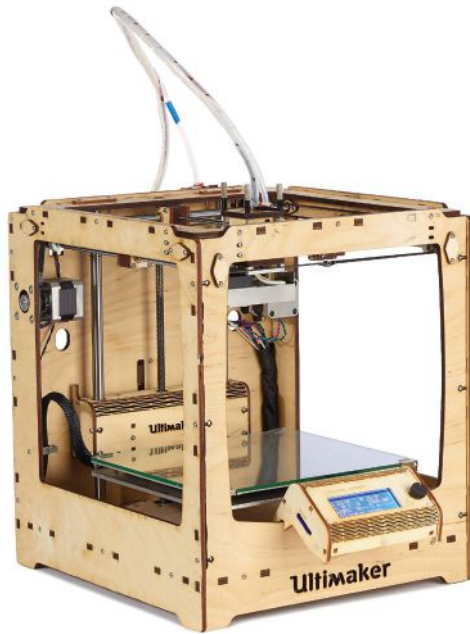

Ultimaker Original+ | ultimaker.com

- **Price as Tested** \$1,600 (kit)
- **Build Volume** 210×210×205mm
- **Bed Style** Heated glass
- **Temperature Control?** Yes
- **Materials** PLA, ABS (others encouraged)
- **Print Untethered?** SD card, OctoPrint compatible
- **Onboard Controls?** Yes
- **Host Software** Cura
- **Slicer** CuraEngine
- **OS** Mac, Windows, Linux
- **Open Software?** Cura/CuraEngine: AGPLv3
- **Open Hardware?** Auxiliary files: CC BY-NC 3.0

RELEASED JUST OVER THREE YEARS AGO, THE ULTIMAKER ORIGINAL KIT JUST KEEPS GETTING BETTER.

The Original+ has a slew of enhancements that include a heated glass bed (upgrade kit available), an improved Z-axis, new electronics, and Ulticontroller onboard controls with SD card are now included.

BUT THAT'S NOT ALL ...

Another welcomed improvement is the move to a 3-point bed leveling system, which is much easier and quicker than the previous 4-point bed adjustment system. Additionally, there have also been changes to the extruder. The polypropylene fan duct has been replaced with a sturdy metal one and new plastic spacers and clips are used in the assembly of the hot end. Our test machine was fully assembled (and a prototype, which may have hurt XY, Z scores) but judging from our personal kit build experiences, this redesigned extruder will be significantly easier to build.

PERIODIC MAINTENANCE

The overnight prints on this machine

performed extremely well and reliable.

One thing we did notice was that one of the nuts was a little loose when we came in the next morning. Experience using other Ultimaker Originals for the last two years has shown that it's important to tighten all of the nuts every three to six months.

LET THERE BE LEDS?

The only thing that this machine might be missing is a lighted build platform. That is one of the many things that the Ultimaker 2 did extremely well, and it seemed to be a big hit. I imagine that Ultimaker will eventually release a lighting kit or, perhaps, *Make: Projects* will come up with a clever tutorial on how to light up this machine.

CONCLUSION

This printer packs a huge value. It puts a huge build volume, refined quality, reliability, and incredible speeds into a continually upgradable, well-supported machine. It may not be as sleek as the Ultimaker 2, but at nearly half the price (\$1,600) it's a great bargain. With its low maintenance and high performance, this hackable machine is great for any maker. 🛠️

PRINT SCORES

● Accuracy	1	2	3	4	5
● Backlash	1	2	3	4	5
● Bridging	1	2	3	4	5
● Overhangs	1	2	3	4	5
● Fine Features	1	2	3	4	5
● Surface Curved	1	2	3	4	5
● Surface General	1	2	3	4	5
● Tolerance	1	2	3	4	5
● XY Resonance	FAIL	PASS			
● Z Resonance	FAIL	Pass			

PRO TIPS

Regularly retighten nuts on the sliding blocks and the extruder, they tend to loosen.

WHY TO BUY

Continually upgradable, extremely fast and reliable printing, excellent hackability, great surface finish, large build area, heated glass, low maintenance.

How'd it print?



YVES SINNER is a Luxembourg/Europe-based blogger, 3D-printing enthusiast, innovation expert, and start-up advisor. You can follow him and his brother Michel on 3Dprintingforbeginners.com.



NICK PARKS is an engineering intern at *Make: Labs* and is studying mechanical engineering at Santa Rosa Junior College.

BUKOBOT 8 V2 DUO

Tweakable design, multi-material capabilities, and great technical support

WRITTEN BY TOM BURTONWOOD

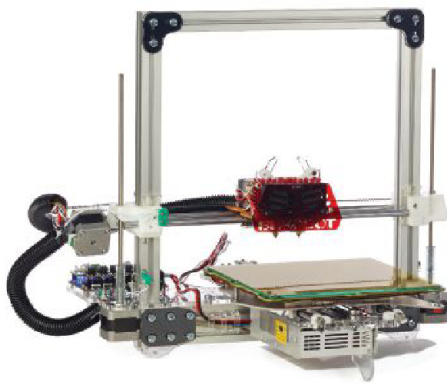

Brian Kaldorf

THE BUKOBOT 8 V2 DUO KIT (SENT TO US ASSEMBLED) SEEMS LARGELY UNCHANGED FROM THE SINGLE EXTRUSION MACHINE WE REVIEWED LAST YEAR,

apart from the addition of a second Spitfire extruder. With its hackable, RepRap-style design (STL/ DXF files available), it doesn't look like a beginner's machine and that's probably a good thing.

Performance-wise, the Bukobot 8 v2 Duo did not work as well as might be expected during the Shootout testing weekend. Initially I tried to use Cura as instructed in the documentation, but the configuration files from the Deezmaker website repeatedly crashed the program. Manually configuring Cura did not fare much better for me, so instead I opted to use legacy Slic3r profiles downloaded from the Bukobot site. These profiles printed well, scoring respectable marks on the Accuracy, Backlash, and Bridging probes.

This machine landed roughly in the middle of the pack after two days of intensive testing, but its pedigree and construction suggests it could do much better. 🍷

PRINT SCORES

Accuracy	1	2	3	4	5
Backlash	1	2	3	4	5
Bridging	1	2	3	4	5
Overhangs	1	2	3	4	5
Fine Features	1	2	3	4	5
Surface Curved	1	2	3	4	5
Surface General	1	2	3	4	5
Tolerance	1	2	3	4	5
XY Resonance	FAIL	PASS			
Z Resonance	FAIL	PASS			

PRO TIPS

Slic3r + Repetier-Host preformed better than Cura. To dial in the machine, use online forums and technical support.

WHY TO BUY

Tweakable design, multi-material capabilities, and great technical support.

Bukobot 8 v2 Duo | bukobot.com

- Price as Tested \$1,499 (kit)
- Build Volume 200×200×200mm
- Bed Style Heated
- Temperature Control? Yes
- Materials ABS, PLA, Nylon, Polycarbonate, PVA, HIPS, TPE
- Print Untethered? SD card, OctoPrint compatible
- Onboard controls? No
- Host Software Cura
- Slicer CuraEngine
- OS Mac, Linux, Windows
- Open Software? Third-party software
- Open Hardware? Auxiliary design files: CC BY-NC-SA 3.0

BUKITO V2

Hackable, tweakable, and tinkerer-friendly

WRITTEN BY KACIE HULTGREN

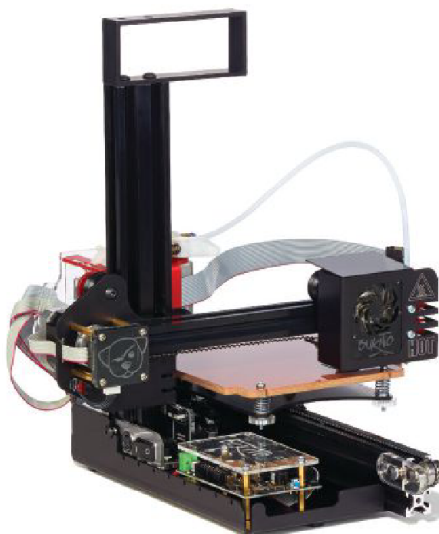

Brian Kaldorf

THE BUKITO IS A FUN AND COMPACT PRINTER THAT'S SO RIGID AND LIGHT, IT CAN PRINT IN PLA OR NYLON —

upside down! It's a perfect travel-size printer for demos and workshops. We like the large platform-leveling knobs, unique syncro-mesh timing belts, and rigid V-Slot extrusions. The all-metal hot end supports high-temperature printing, and it ships with a nylon-friendly Garolite platform.

In our tests, print performance in PLA was average. The great ratings for Accuracy and Backlash indicate a machine that's well built and tuned, but these scores were outweighed by poor Overhang and Bridging scores. The optional cooling fan (absent on ours) could greatly increase the Bukito's overall ranking.

For an uninitiated consumer, the software setup and lack of a slicing guide will be a little daunting, but experienced users won't have any issues with the online documentation. The company's lead engineer addressed many of our anonymous support questions personally. 🍷

PRINT SCORES

Accuracy	1	2	3	4	5
Backlash	1	2	3	4	5
Bridging	1	2	3	4	5
Overhangs	1	2	3	4	5
Fine Features	1	2	3	4	5
Surface Curved	1	2	3	4	5
Surface General	1	2	3	4	5
Tolerance	1	2	3	4	5
XY Resonance	FAIL	PASS			
Z Resonance	FAIL	PASS			

PRO TIPS

Wish it had a display? Use Marlin's auto-start function for prints that begin from SD on startup.

WHY TO BUY

Portable, nylon-capable out of the box, tinkerer focused.

Bukito v2 | deezmaker.com

- Price as Tested \$899 (kit)
- Build Volume 140×150×125mm
- Bed Style Unheated Garolite
- Temperature Control? Yes
- Materials PLA and Nylon 618
- Print Untethered? MicroSD card, OctoPrint compatible
- Onboard controls? Yes
- Host Software Repetier-Host
- Slicer Slic3r
- OS Mac, Linux, Windows
- Open Software? Third-party software
- Open Hardware? CC BY-NC-SA design files "forthcoming"

FORM 1+

Create highly detailed sculptural prints – fast

WRITTEN BY LUIS RODRIGUEZ

Form 1+ | formlabs.com

- **Price as Tested** \$3,299
- **Build Volume** 125×125×165mm
- **Z Resolution** 25/50/100 microns (0.025/0.05/0.10mm)
- **XY Resolution** 300 microns (0.30 mm)
- **Materials** Clear, White, Gray, and Black detail UV curable resin
- **Print Untethered?** Kickoff via USB
- **Software** PreForm
- **OS** Mac, Windows
- **Open Software?** No
- **Open Hardware?** No



THE UPGRADED FORM 1+ IS SLEEK AND THE DESIGN IS FLAWLESS.

No part of the construction feels weak or cheaply made. Operation is silent and underwhelming. The resulting prints are not. The Form1+ is a stereolithography system (SLA), drawing each slice of the model into liquid resin with a laser to harden it. As the build platform moves up, a solid model appears out of the liquid.

FASTER AND MORE ACCURATE

The Form 1+ features a new, 4x more powerful laser that cuts print time in half, a re-engineered galvanometer control system to increase speed and accuracy, and an improved peel mechanism. Capable of 0.1, 0.05 and 0.025mm layer heights and with a minimum feature size of 0.3mm, it can't match the B9 or ProJet's claimed resolutions, but they can't match its build area.

MULTICOLOR MATERIAL STORAGE AND SWAPPING

The included injection-molded resin tanks have been upgraded to a light-blocking orange acrylic, enabling safe storage of unused resin with the included lids. This allows the user to switch resin colors between prints.

EXTENSIVE DOCUMENTATION

The included quick-start guide gets you unboxed and up and printing in less than 30 minutes, and it includes information on how to setup your included finishing station. Plus, Formlabs has an extensive support site (formlabs.com/en/support).

THE FORM 1+'S UPGRADES MAKE AN ALREADY-SOLID USER EXPERIENCE (WE CALLED ITS PREDECESSOR A "MODERN MARVEL") EVEN BETTER.

PREFORM SOFTWARE

The Form 1+ excels at sculptural prints and targets designers. SLA machines must create support structures to enable overhangs (which are removed postfabrication). Formlabs' continually updated Preform software has numerous auto-generating and custom support-material editing functions (which work extremely well), and placement and removal features (added after our testing) that enable advanced control of placement and density, giving designers complete control over where they adhere to print surfaces.

SOME PRINT FAILURES, NO CASTABLE RESIN

We did experience a few failed prints that couldn't be explained. Occasionally we had a layer that did not peel, which means every subsequent layer was blocked from curing, and we had to fish resin chunks out of the vat. One downside for some users is that the Form 1+ does not have castable resin options. (See *B9 Creator* and *ProJet*).

CONCLUSION

The Form 1+'s upgrades make an already-solid user experience (we called its predecessor a "modern marvel") even better. While the cost of the machine is higher than most desktop printers, its output and build volume is unparalleled. For those who want incredible print detail and numerous resin color choices but don't need castable resin, it's an easy choice. ☑

PRO TIPS

- The Formlabs support site is an awesome resource — use the active community forum.
- When prints fail, stop the build early, clean the bottom of the resin tank, and restart. Careful sifting of cured resin will ensure subsequent prints are successful.

WHY TO BUY

The level of detail is ideal for someone making lab apparatus for microfluidics, detailed character animation, sculpture, or jewelry. It's so easy to use that anyone from an artist to a student or teacher can explore this new medium. I work in a science center, and we plan to use it for many different teaching aids and models. From DNA molecules to magnifying tiny insects, you can output a level of detail that is impossible with other 3D-printing technologies.

Formlabs makes its products upgradeable and is currently offering a \$1,200 upgrade package for the previous model owners.

How'd it print?



LUIS RODRIGUEZ is the lead organizer for Maker Faire Kansas City and has been 3D printing since 2009, when he got his first MakerBot Cupcake. Luis works at Science City, where he manages

the Maker Studio and Spark!Lab.
unionstation.org/sciencecity

PRINTING WITH UV-RESIN

UV-resin based printers require a different workflow than thermoplastic printers where the only danger that occurs is proximity to hot beds and nozzles. UV-resin is a chemical that needs to be treated with care. In its liquid form it is an irritant and should be kept away from your skin, eyes, and nose. You will notice a characteristic odor when the lid is open, but you never smell that when the printer is in operation with the lid sealed. Proper use of gloves and paper towels will ensure a clean environment. You should not use this machine in a dusty or dirty workplace — you don't want to contaminate the resin with any sort of particle. Carefully allowing excess resin to drain from the print and preventing drips goes a long way to keeping your area clean. During the review we went through a lot of gloves and wipes to ensure a safe test environment.

PROJET 1200

This tiny, resin-cartridge-fed printer is designed for jewelers and dentists

WRITTEN BY ANDERSON TA



ProJet 1200 | cubify.com/en/ProJet

- **Price as Tested** \$4,900
- **Build Volume** 43x27x150mm
- **Z Resolution** 30 microns (0.03 mm)
- **XY Resolution** 56 microns (0.056 mm)
- **Projector Resolution** LED DLP, effective 585 dpi
- **Materials** VisiJet FTX Green UV curable, castable resin
- **Print Untethered?** Kickoff via USB, wi-fi
- **Software** Geomagic Print
- **OS** Windows only
- **Open Software?** No
- **Open Hardware?** No

AT LONG LAST, 3D-PRINTING INDUSTRY GIANT 3D SYSTEMS HAS ENTERED THE DESKTOP SLA MARKET WITH THE PROJÉT 1200. With a sleek form factor, it is about the size of a mini breadmaker, and it packs a fair bit of technology inside.

SIMPLE, SELF-CONTAINED, NETWORKED DLP

This DLP-based system has a small resin-curing pico projector in its base, and a built-in, post-curing station, which curiously is not large enough to hold a print the height of the build area. Onboard controls are limited to a simple, two-line LCD display and a single green, glowing button. It's possible to send files over USB, but we found it was happiest when networked and receiving files over wi-fi.

TINY MACHINE FOR MAKER PROS

At 43x27x100mm the build area is tiny, but it needs to be due to its design. Unlike the B9 and Form 1+, it does not have a layer-separating mechanism to assist in print release between layers, limiting successful prints to very small objects or ones that have a small, cross-sectional surface area. That said, it's explicitly targeted at a maker-pro audience of jewelers and

dentists who typically work small and use investment-casting processes that require clean burnout. The convenient, but costly (\$490 for a pack of 10) prepackaged VisiJet FTX Green no-ash burnout resin cartridges and \$4,900 price tag reflect this focus.

FIRMWARE MISHAPS AND GEOMAGIC PRINT

After installing Geomagic Print and powering up the machine, we were prompted for a firmware update, which bricked the unit. After multiple frustrating instances of unplugging, powering down and USB reconnecting, it became operational again. We also had some issues with failed prints with large flat bottom surfaces until we got the hang of the workflow.

The Windows-only software has all the simple and most of the advanced features you'd expect, but support customizability felt limited compared to the extensive support-manipulation options available in the B9 Creator and Preform software.

CONCLUSION

Advanced features aside, it's very easy to use, and there's no resin to pour. Pop in and lock down a resin cartridge, load the build platform, and prep and print. 🍷

PRO TIPS

- If model has large, flat bottom surfaces, angle slightly with "Interactive Transform." Click "Auto Support." Turn view to bottom, select "Manual Support," and drag slider to "Large." Add extra supports and click print.
- Don't try to pick failed prints out of the cartridge, you may puncture it and make a mess.
- Geomagic print expects a raft and offsets the Z 0.09 by default, modifiable in preferences.
- For better print adhesion, try roughing up the build platform.

WHY TO BUY

Compact, easy-to-use, networked, maker-pro-ready SLA targeted at jewelers and dentists. Resin that burns out cleanly, designed for metal casting. No fishing around in a vat for failed print floaties, just pop in another cartridge.

How'd it print?



ANDERSON TA is a digital fabrication expert. By day he manages Miller Lab at Rice University where they are researching various applications for 3D printing in the field of tissue engineering and regenerative medicine. By night, he works to promote and make open hardware an option for all. He lives to make things that enable others to bring their ideas to life.

B9 CREATOR V1.2

Tinkerer's machine capable of the finest resolution of printers tested

WRITTEN BY NICK PARKS AND ERIC CHU



Brian Kaldorf

THE B9 V1.2 IS AN UPGRADED VERSION OF THE B9 V1.1 WE REVIEWED LAST YEAR.

New additions include a 1080p projector, a deeper vat, and XY- and Z-axis mechanical improvements. The B9, like the ProJet 1200, is a DLP machine and uses a projector to cure the resin, as opposed to a laser. The new aluminum resin vat is robust and allows resin to be rinsed out with alcohol without having to worry about damaging the acrylic.

Geared towards jewelers who use lost-wax (in this case, resin) casting methods, the B9 is unusual in that it can be configured for different resolutions and corresponding build area sizes. The new, higher resolution DLP projector enables more detail in the XY plane, producing finer attributes. At the minimum recommended Cherry-resin layer height of 25-50 microns (0.025 – 0.05mm) and 30 microns (0.03mm) in the XY axes the B9 is capable of the finest resolution of all the printers tested.

However, we had some issues, and it took many tries with lots of tinkering and fine-tuning to get successful prints; we often ended up with a bunch of partially cured resin floaties in the resin tank. When it printed, it printed very well. Unfortunately our testing was constrained to 70 microns XY with the Red resin due to a firmware issue that blocked us from changing settings. ❌

WHY TO BUY

Castable resin, extremely fine detail capabilities. Target market is jewelers and other artisans who use lost-wax casting methods. But lots of tinkering and fine-tuning required

PRO TIPS

- Use small batches of resin to avoid having to throw out large quantities when prints fail.
- Buy yourself some masks or a respirator because this machine requires a lot of user interaction.

B9 Creator v1.2 | b9creator.com

- **Price as Tested** \$5,495
- **Z Resolution:** 25-100 microns (0.025-0.1mm), depending on resin used
- **XY Resolution:** 30/50/70 microns (multiple configurations)
- **Projector Resolution:** 1920 x 1080 (1080p)
- **Build Volume:** 57.6 x 32.4mm at 30µm x-y, 96 x 54mm at 50µm x-y **TESTED:** 104 x 76.6mm at 70µm x-y
- **Materials:** Red or Cherry UV curable, castable resin.
- **Print Untethered?** No
- **Software:** B9 Creator
- **OS** Mac, Windows, Linux
- **Open Software?** Host software: GPLv3; firmware: CC BY-SA 3.0
- **Open Hardware?** Auxiliary design files BOM, electronics: B9Creator 3D Printer Noncommercial Hardware License

SLA SYNOPSIS

WRITTEN BY ANNA KAZIUNAS FRANCE

AS DISCUSSED IN "WHAT IS PRINT QUALITY?" ON PAGE 34, our Dimensional Accuracy probe measures a printer's ability to fabricate dimensionally correct geometries in the XY plane. Resolution is the absolute limit of what the technology is possible of producing.



Jeffrey Braverman

Dimensional Accuracy

ACTUAL DIAMETER 20MM



Machine	Accuracy	Precision
Form 1	-0.14	+/- 0.08mm
ProJet 1200	0	+/- 0.21mm
B9 Creator	-0.25	+/- 0.06mm

Resin shrinkage may play a role, but we were unable to test during Shootout.

RESOLUTION

The circular text at the top of the *Make: Rook* test print is 0.87mm (870 microns) — 0.9mm (900 microns) tall in the XY plane (depending on the letter), and measures 0.17mm (170 microns) in Z plane. Rook dimensions: X: 14.33 Y: 14.34, Z: 24mm.

PROJECTOR-BASED (DLP): ProJet 1200, B9 Creator

In projection-based systems like the B9 Creator and ProJet 1200, the desired Z resolution or "layer height" and projector resolution determines the XY print size. Increased resolution reduces the possible print area.

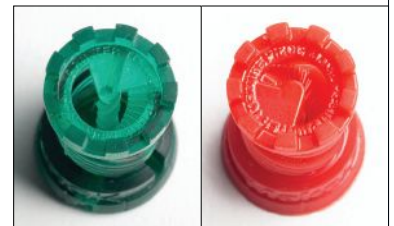

LEFT: ProJet 1200: Printed at 30 microns (only setting), projector 585 dpi

RIGHT: B9 Creator: Printed at coarsest 70 micron (0.07mm) option (unfortunately, firmware issues kept us from configuring and testing at higher resolutions), projector 1080p

LASER BASED: Form 1+

In laser-based systems the minimum feature size (finest points / walls possible) is determined by laser spot size. ❌



Form 1+: Printed at default 50 micron (0.05mm) layer height, machine has 300 micron minimum feature size.

FUSED-FILAMENT FINDINGS

This year's trends in desktop 3D printing

WRITTEN BY ANNA KAZIUNAS FRANCE AND KACIE HULTGREN

TO UNCOVER THIS YEAR'S PRINTER TRENDS AND PROVIDE THE QUANTITATIVE COMPARISON DATA promised by Andreas Bastain's test protocol, we diligently recorded every piece of data as we ran our test, and probes were scored by the entire team. As we crunched the data, a number of trends emerged that show the state of current 3D-printing hardware and software.

PRINT QUALITY: ALWAYS ROOM FOR IMPROVEMENT

Assessing print quality was a big part of our testing this year, but it's important to remember that these tests were conducted

over a short duration and were intended to mimic the "out of the box" experience of a new user.

Print quality can always be improved, as long as the printer's software allows for the creation of custom profiles. All test probes were run using vendor-provided stock profiles and recommended settings in Ultimachine orange PLA, except where noted with an asterisk in the chart. Those machines needed special proprietary filament or continually jammed with PLA. We aimed for consistency: if a machine claimed to be able to handle non-OEM PLA, that's what we used.

REPLICATING BENCHMARKS: IS DESKTOP 3DP IMPROVING?

In our print scores chart, we've also added rankings for two "retired" machines that we consider benchmarks: MakerBot's Replicator 1 and 2. When the surface finish of our 5th Gen Replicator's prints provoked unfavorable comparisons to the Rep 2 during the Shootout (see page 54), we decided to remove all doubt and run the prints on our own stock machines. Rep 1 owners jumped in as well, but these 3-year-old machines (engineered for ABS) could use some active PLA cooling — something we'd like vendors who produce similar models to note and include. Thankfully, most ma-

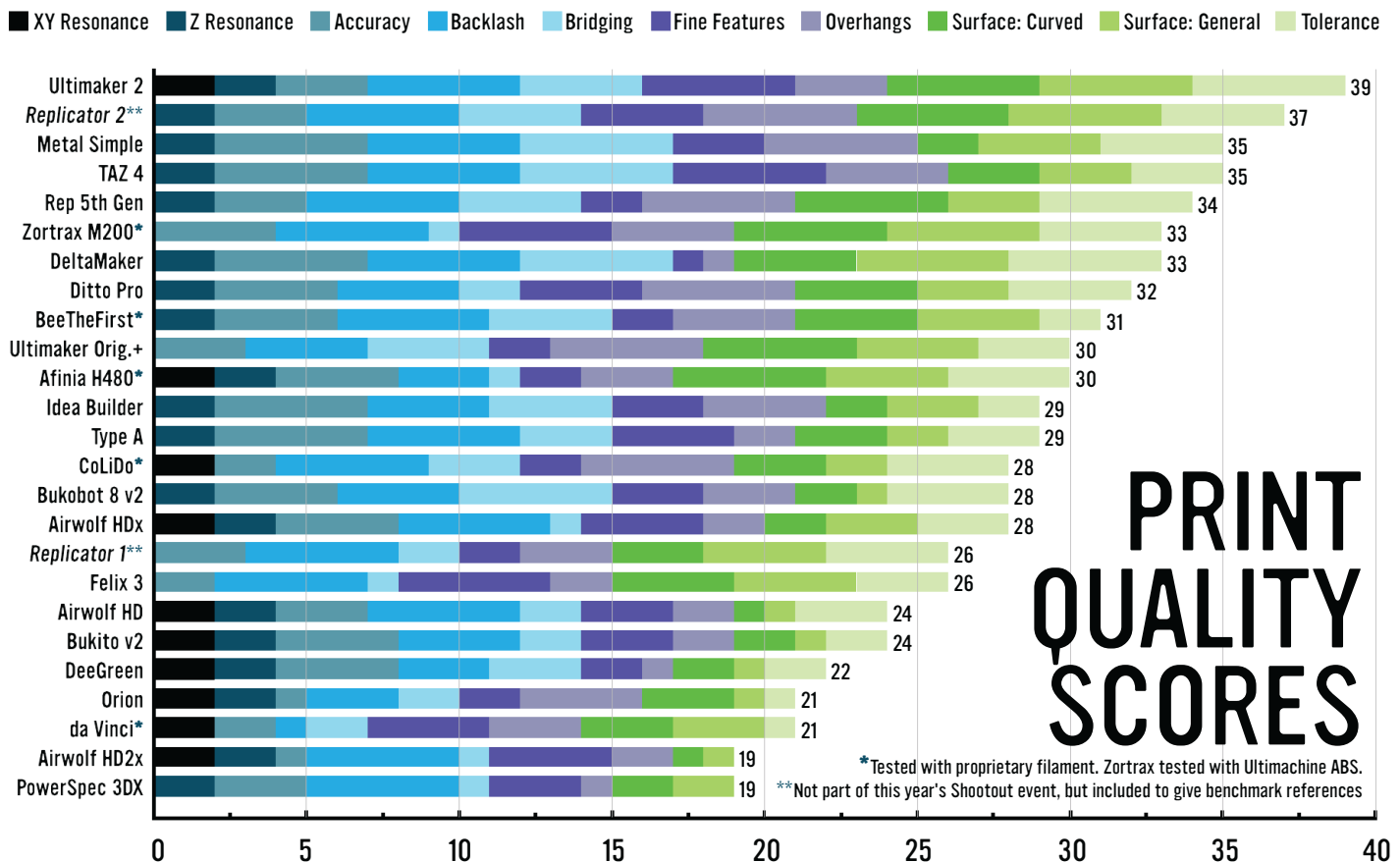

chines surpassed the Rep 1, but as our test team is well aware, software (particularly the slicer used) makes a big difference with the print quality of any hardware.

RISE OF INTEGRATED CURAENGINE

A vast majority of printer vendors continue to be dependent on free, third-party software toolchains. Of the 23 fused-filament printers in our Shootout, only eight developed their own host software and a mere six created their own slicers.

Repetier-Host continues to be a popular vendor recommendation but has declined in popularity with hardcore enthusiasts after they closed their source early in 2014. While the use of Cura as a client has increased four-fold from last year, use of Ultimaker's open-source slicer, CuraEngine is up a whopping eight-fold (overtaking Slic3r) due to its integration into several vendor's software packages, including BeeTheFirst's "BeeSoft," DeeGreen's "DeeControl," "Tinkerine Suite," and Type A Machine's Cura.

MOST SLICERS ARE HARDWARE AGNOSTIC

Throughout the reviews in this issue, we often recommend using a different slicer than the vendor recommended. That's because many printers run open-source firmware variants that have descended mostly from Marlin, but also early Maker-Bot firmware (Google Sailfish firmware). If your printer runs Marlin and takes straight G-code, you have a wider choice of Slicers (Slic3r, CuraEngine, SFACT, KISSlicer, Skeinforge — although we recommend starting — and sticking with — Cura), and you'll be able to print wirelessly via OctoPrint (see page 74). If your machine takes .X3G files (like the PowerSpec), then we advise you to use MakerWare, it's much more advanced than ReplicatorG.

CREDIT WHERE CREDIT'S DUE

The 3DP Test Team would like to thank Brad Hill (aka goopyplastic and the creator of LittleRP littlerp.com) for creating the *Make: Rook* (A) used to test this year's crop of SLA machines. Download the model and test it yourself: makezine.com/go/rook

We've mentioned him in "Print-in-Place" (see page 36), but another formal shout-out goes to le FabShop's Samuel N. Bernier who designed the *Maker Faire Robot Action Figure* print (B) featured in our reviews: thingiverse.com/thing:331035

PRINT QUALITY CAN ALWAYS BE IMPROVED, AS LONG AS THE PRINTER'S SOFTWARE ALLOWS FOR THE CREATION OF CUSTOM PROFILES.

HARDWARE AND SOFTWARE OPENNESS

From AGPLV3 to auxiliary design files CC BY-NC-SA 3.0, there are many shades of gray, but not as many as we'd like.

Overall 3DP software openness has decreased dramatically since last year, mostly due to the Repetier-Host effect. We've called out the licenses on all the hardware and software files we could find (and we searched hard) on each review. As Michael Weinberg mentioned, there's confusion about open-source licensing (see page 14). Check out oshwa.org and opensource.org for what qualifies.

SPEED VS. QUALITY

3D printing is a slow process, and those looking to make an investment in a new machine want to know which printer is the fastest. It is a difficult question to answer, because it's challenging to sort through the manufacturer claims.

Some tout top speeds of 150-200mm/s, but it's important to realize that most modern 3D printers use acceleration, gradually speed up along straightaways, and slow down to round corners. On small prints most 3D printers don't reach anywhere near their maximum speed, and some slicers deliberately slow down parts of the print for extra adhesion or better surface finish.

But we don't just want fast printers — we want fast, high-quality prints. There are trade-offs when a printer runs too fast. The extruder can skip, causing clogs. Problems like XY resonance and backlash become more pronounced. Retraction gets sloppy. Layer adhesion and surface quality can suffer. We tried to find the sweet spot — the printers that were above average on both counts. Many of the lower speed printers can run much faster, and some of high-speed printers can be slowed down to print with better quality. ☺



A

The surface finish scores were calculated using the curved head and general body surfaces of the robot.

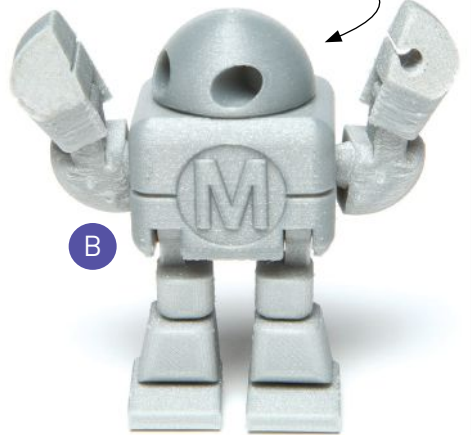

B

Slicers: CuraEngine Overtakes Slic3r

Year	Slic3r	CuraEngine
2012	53%	6.7%
2013	55%	5%
2014	30.43%	39.13%

Host Software: Cura Ties Repetier-Host

Year	Repetier-Host	Cura
2012	18.3%	6.7%
2013	32.5%	5%
2014	21.74%	21.74%

Openness of Slicing and Host Software

Year	Open	Closed
2012	77.5%	22.5%
2013	72.5%	28%
2014	63.05%	36.96%

THE STANDOUTS

We've run all the tests and based on our experiences we can confidently say that these machines are all top performers. Each has things that make it great, but a few have some restrictions and limitations. Based on our team's extensive 3DP experience, we know that the value of a machine is determined by a combination of price, quality, functionality, and cost of ownership. **WHICH ONE IS RIGHT FOR YOU?**

BADGES



Turnkey = Easy, fast out-of-the-box experience

Portable = Compact, has handle, will travel

Smart Design = Simplified, fresh take on hardware and/or software

Open Source = Company has released their code, original file formats, and placed their designs under an open license for your hacking pleasure

Software Agnostic = Slicer and control software choices available

Bells & Whistles = Extra features that most machines don't have



Hidden Costs = Proprietary consumables

Limitations = Limited software settings, no user temperature control, or intentionally restrictive warranty regarding materials

BEST IN SHOOTOUT PRINT QUALITY ULTIMAKER 2

With the undisputed best scores in our print-quality tests (by a whopping 4 points), the Ultimaker 2 is the machine to beat.

- + Open-Source Software
- + Software Agnostic
- + Turnkey

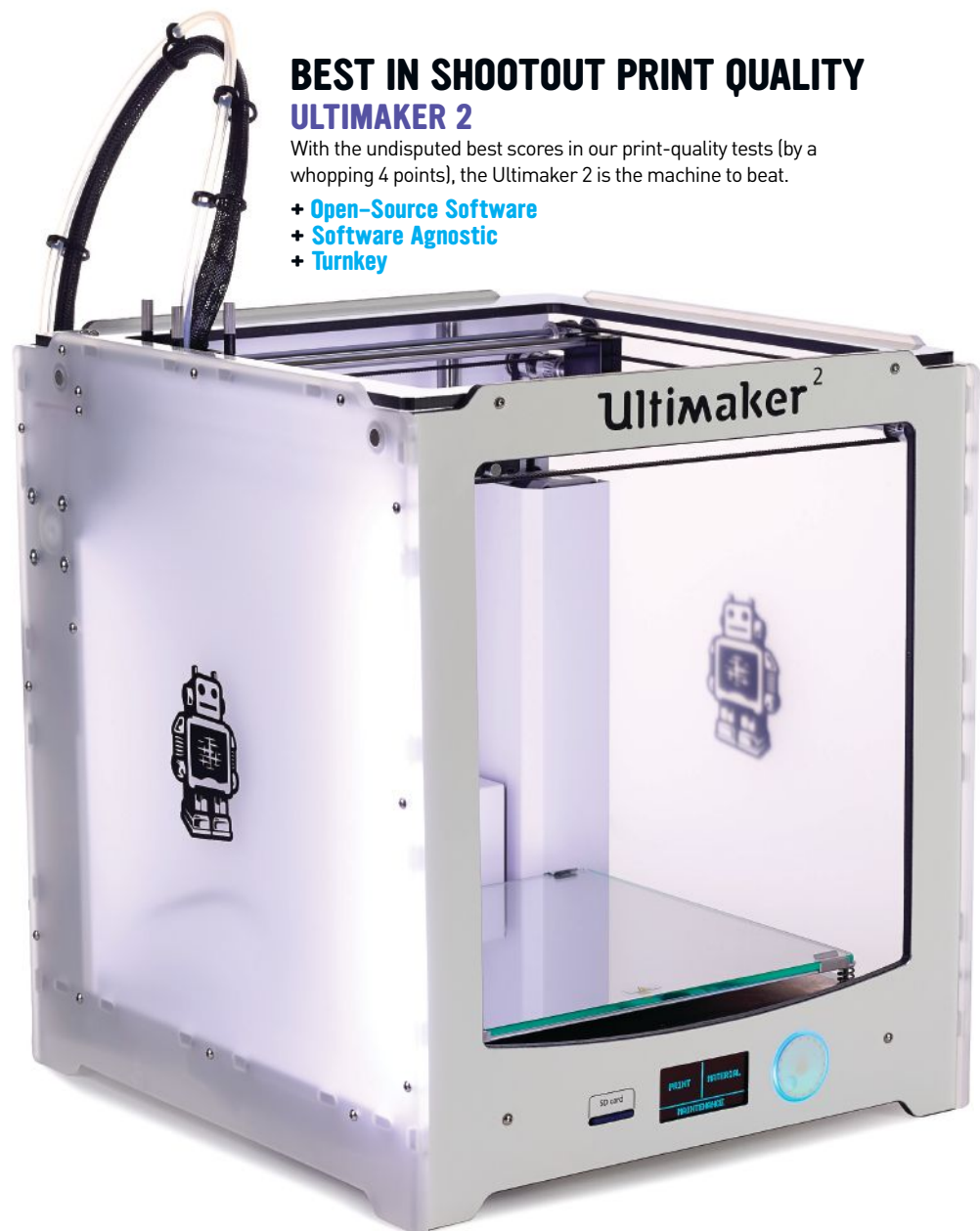

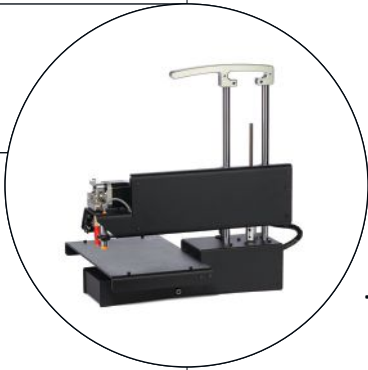

THIN WALLET WIN
PRINTBOT SIMPLE METAL

At \$599, the Printbot Simple Metal is affordable, auto-leveling, AND tied for second for print quality.

- + Software Agnostic
- + Bells & Whistles
- + Portable

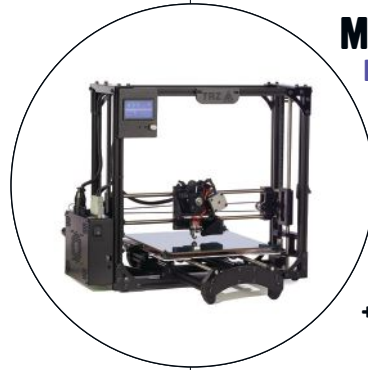

MOST MAKER MACHINE
LULZBOT TAZ 4

Everything a maker wants. Open-source underpinnings, big heated-glass build volume, high-temperature and multi-material capable with the custom Flexystruder. Plus, the excellent print quality and the detailed documentation needed to level up.

- + Software Agnostic
- + Open-Source Hardware



FEATURE PACKED
REPLICATOR 5TH GENERATION

MakerBot's updated flagship machine is full of shiny new tech, but it comes with a hefty price tag, hidden costs, and warranty-voiding materials limitations.

- + Bells & Whistles
- + Turnkey
- Hidden Costs
- Limitations

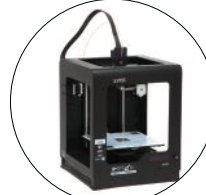

HAPPY MEDIUMS

Not quite top of the charts, but high-quality prints, a large build volume, and below-average price make these machines solid choices.

ZORTRAX

- + Turnkey
- Limitations



DITTO PRO

- + Turnkey

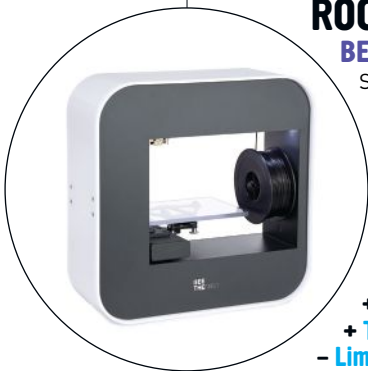

ROOKIE OF THE YEAR
BEETHEFIRST

Something new! An easy-to-use, attractive, portable machine with stripped-down, custom open-source software that uses smart hardware design (instead of sensors) to make bed leveling easy.

- + Smart Design: Hardware
- + Open-Source Software
- + Portable
- + Turnkey
- Limitations
- Hidden Costs



SMART SOFTWARE INTEGRATION
DELTAMAKER

The seamless integration of Octo-Print with preconfigured onboard Cura slicing is the first we've seen in a commercial machine out of the box, and something we'd like to see other vendors adopt and attribute.

- + Software Agnostic
- + Turnkey
- + Smart Design: Software Workflow & Integration



RELIABLE PERFORMER
AFINIA

A solid bet for the third year running. It's small build area and software and materials limitations mean that it's not for everyone, but it's ease of use and continual upgrades make it shine.

- + Bells & Whistles
- + Turnkey
- Hidden costs
- Limitations

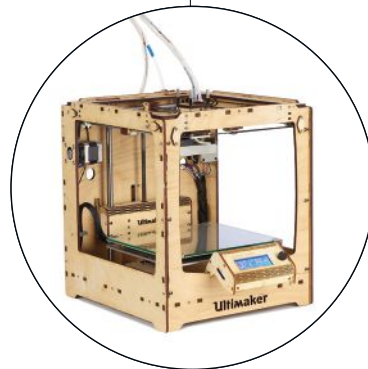

MOST UPGRADABLE
ULTIMAKER ORIGINAL+

With continual support and available upgrades from Ultimaker, this beloved classic just keeps getting better.

- + Open-Source (Custom) Software
- + Software Agnostic

ARDUINO GETS PHYSICAL

We take an early look at the Materia 101, Arduino's first foray into 3D printers

WRITTEN BY MIKE SENESE

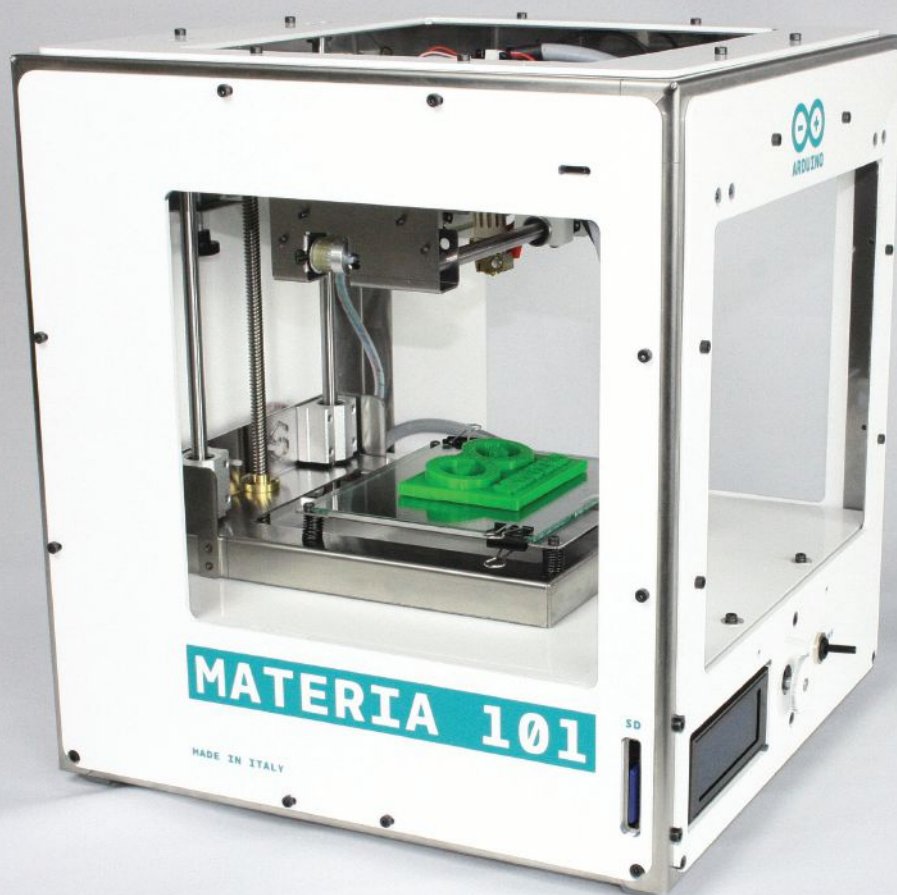

ARDUINO, BEST KNOWN FOR CREATING AN EASY-TO-USE MICROCONTROLLER

revolution, is moving into 3D printing. In early October at Maker Faire Rome, the Turin, Italy-based company debuted a boxy, white-and-teal FFF printer called the Materia 101. The machine is based on the Sharebot Kiwi 3D, a diminutive printer made by the largest Italian 3D printer manufacturer. Sharebot will assemble the Materia 101 printers for Arduino.

The Materia 101's features are simple — its print dimensions measure 140mm×100mm×100mm (roughly 5 1/2"×4"×4"). The unheated bed only supports PLA plastics; the extruder takes standard 1.75mm filament. The front of the housing contains an LCD, push-button scroll wheel, and — oddly — a large power switch that prominently protrudes from the case. An SD card slot on the left side of the machine offers untethered printing. The printer also comes with a separate, matching filament spool holder.

Arduino doesn't see its printer as the end product, however. Available in kit form for around \$800 or preassembled for about \$1,000, the Materia 101 is a fully open-source endeavor that can be modified to meet your needs — something Arduino actively promotes. Want a larger print area? Desire a heated print bed? Need to access the printer's Arduino Mega capabilities for a separate project? The schematics and information are all available to help you do this.

This machine is the biggest piece of hardware that Arduino has launched to date. It's an interesting move for the company, but not an entirely disconnected element, as many of the printer developments in the 3D community have used Arduino boards for control. Moreover, it's a further indication of how bigger companies are starting to embrace and release consumer 3D printers.

We look forward to playing with this machine as soon as it's available. 🍷

ONES TO WATCH

Powder is coming to a desktop near you **WRITTEN BY CRAIG COUDEN**

FUSED-FILAMENT MACHINES ARE HITTING THEIR STRIDE AND RESIN-BASED printers are about to become mainstream. Meanwhile, the next generation of at-home 3D printers will use lasers, heat, or liquid to bind powders into solid materials. This process is self-supporting — advantageous because no extra breakaway branches are needed to hold up dangling parts of your print. It can also work on a variety of materials — we'll see plastics and minerals at first, but metal-printing machines won't be far behind. Here are a few to keep your eye on.

Blueprinter



BLUEPRINTER

Begun as a master's thesis, Danish company Blueprinter uses a process similar to selective laser sintering (SLS), but melts the powder with a thermal printhead (selective heat sintering) instead of a laser. Priced around \$25,000, the company has sold limited quantities in Europe since 2012, but is currently expanding. blueprinter.dk



SPARK AUTODESK

With rapidly growing support before full details have been released, Autodesk's Spark software looks to quickly become the go-to for 3D printing. It aims to provide repair capabilities, slicing, toolpath generation, and printing services in one streamlined workflow from your desktop or the web.

Featuring an open API and compatibility with a variety of materials, Autodesk has already announced partnerships with Dremel (see page 56) and Local Motors (page 72) to use Spark, and their first foray into hardware, a resin printer called Ember, will help them showcase what the software can really do. spark.autodesk.com



SNOWWHITE SHAREBOT

The Italian printer maker is expanding beyond its popular FFF machines and Arduino partnership into SLS powder printers with the SnowWhite (working name). Targeting an early 2015 launch, this printer is also expected to cost about \$25,000. sharebot.eu

Sharebot



SINTRA SINTRATEC

Switzerland-based Sintratec's SLS printer is still in development, but they're aiming for an unheard of price of \$5,277. We won't know the outcome of their Indiegogo campaign by press time, but using diode-based lasers instead of expensive CO₂ lasers will help keep costs down. sintratec.com

Sintratec

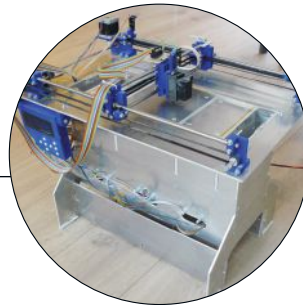

PLAN B YVO DE HAAS

Made from off-the-shelf 3D and inkjet printer parts, Haas' Creative Commons-licensed machine uses gypsum powder and a liquid binding agent for prints. The results are delicate and require some postprocessing. Haas puts the cost to build one at under \$1,200; a work-in-progress manual is on his website. ytec3d.com/plan-b

Yvo de Haas

Autodesk



RAPID

WRITTEN BY NATHAN HURST

ROADSTER

It's drivable, with a fully 3D-printed body, and it's available soon.



Local Motors

The automotive industry is well acquainted with 3D printing; it's a common tool for prototyping, especially for parts and models. But Strati, designed by Michele

Anoè, is the first drivable car with a wholly 3D-printed body.

A low-riding roadster with an open cockpit and an electric motor, the Strati glides at speeds up to 50 mph. Its dark features accentuated with red seats and white wheels give it a slick appearance. What stand out most, though, are the thick horizontal layers, visible leftovers of the fused filament fabrication process that makes the car unique.

Strati is just one offering from Local Motors, an unconventional Phoenix-based transportation company that combines cooperative design (they have a mandatory Creative Commons sharing policy) with micro manufacturing. But it's the best example yet of what CEO and co-founder Jay Rogers says are Local Motors' primary goals: speed up car manufacturing and address 3D printing's greatest challenge — making useful, complete products.

"There is a fundamental difference between printing a beautiful object and saying, I just need a structure and I'm going to let a knife, or a mill, come along afterward and make it as functional or beautiful as I need it to be," says Rogers. With Strati, Local Motors ignored the typical concern of high-resolution printing, opting instead for a fast process that produces a structurally sound body and then milling it to its final shape.

Strati was the winning entry in a competition for Local Motors community members. The designers didn't set out just to build a 3D car, but to make cars easier to build. Their biggest target for innovation was to reduce the part count, from the tens of thousands in a typical car to just 49 in Strati's case.

Into the body they placed the motor and components from a Renault Twizy. The result is undergoing crash testing and certification as a

Neighborhood Electric Vehicle. Rogers expects Strati to be available for purchase within the next year.

With the contest, Local Motors was encouraging designers to adapt the design to the technology, says James Earle, an advanced manufacturing engineer for the company. Additive manufacturing has some restrictions that traditional manufacturing doesn't (and vice versa). "The process really kind of informs the design," Earle says. "When you increase the scale, there are other factors you have to account for."

He points specifically to thermal contraction — ABS tends to shrink as it cools, and a 10-foot print can shrink quite a lot. So they used plastic pellets infused with carbon fiber, which keeps it from shrinking as much, while adding stiffness and tensile strength.

All 212 layers are printed on a Big Area Additive Manufacturing printer from Cincinnati Incorporated, which has a 12'x7'x3' bed. After printing, a 5-axis CNC from Thermwood does aesthetic machining and cleans up the mounting brackets. Finally, it's assembled quickly, thanks largely to the small number of parts.

Therein lie several of the car's advantages. "Any time you reduce the complexity of a system, you reduce the propensity for something to break," says Earle. Beyond that, he adds, the method plays to one of 3D printing's biggest advantages: mass customization. Eventually, he predicts, customers will be able to help design even the shape and size of their own car.

What's more, Local Motors can greatly reduce the time to market. Where car development can often take 5 to 7 years, Rogers plans to release model updates up to 10 times per year, bringing transportation up to pace with software and phone releases. "It's going to put car building in the hands of younger and more nimble people," he says. "I think this is going to unleash an entire different wave of people who are engaged in hacking their car ecosystem." ❧



Jeffrey Braverman



Erik Fuller

From digital rendering to 3D-printed reality in just six months, Local Motors' Strati aims to accelerate automotive innovation, says CEO Jay Rogers (far right).

UNTETHER YOUR 3D PRINTER

Host software frees your computer and lets you control your printer from anywhere on the web.

WRITTEN BY MATT GRIFFIN

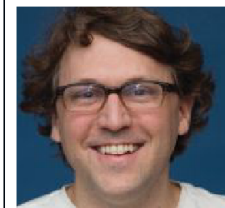

MATT GRIFFIN is director of community and support for Adafruit Industries, where he hosts the weekly "3D Hangouts" live web video series. His new book *Design and Modeling for 3D Printing* is coming soon from Maker Media.

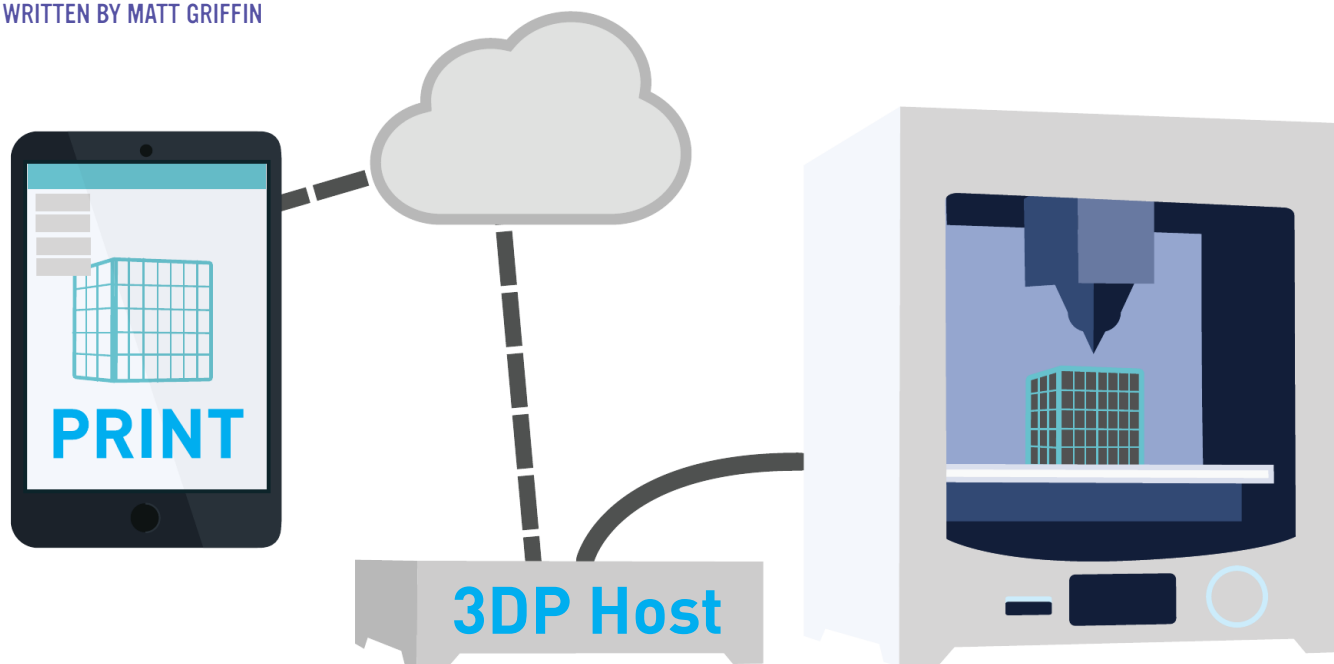

OCTOPRINT FEATURES

- Untether your printer from your computer, for printing over a network — wired or wireless — from any web browser
- Remote printer control software with custom-configurable controls
- Monitor your print progress and temperature
- Use live webcam feed to take reference shots or automatically film a time-lapse movie
- G-code visualization (even while printing) and file management
- Printer-agnostic — can interface with a variety of electronics and firmwares (Marlin, Sprinter, Smoothie) to operate a broad range of machines

TIRED OF TYING UP YOUR LAPTOP WITH LONG PRINT JOBS? Then you're ready for 3D-printer host software. It acts as a web server so that other computers and mobile devices can control your printer over a local network, or even the cloud.

Host software lets you monitor your printer's temperature, percentage of job complete, filament remaining, even a live webcam to watch your print's progress. And it's small enough to run on affordable embedded computers such as Raspberry Pi, BeagleBone Black, or pcDuino!

OCTOPRINT

At the heart of host software's rising popularity is the free and open-source project

OctoPrint (Figure A), created by software engineer Gina Häußge, and its community-distributed, easy-to-install OctoPi image.

On Christmas 2012, Häußge forked the code on Github for the open-source printer host Cura as the start of her new "Printer WebUI" to untether her printer from her computer and control it via a web browser. OctoPrint (octoprint.org) became a project of passion she would develop entirely in her free time for two years.

This past August, the Spanish technology company BQ hired Häußge to continue open-source development of OctoPrint full time — with a team of developers, UI and UX designers, QA department, and tech support team to back her up.

WHO USES IT?

Anyone using a FFF-style desktop 3D printer with Marlin firmware or its variants. OctoPrint is popular among 3D printer hobbyists, the RepRap community, and hardware/software hackers looking for custom functionality. It's incompatible with the .xg3 files used by MakerBots.

STRENGTHS

A large, active community of collaborators and users (Figure B) coupled with investment from BQ ensures that OctoPrint remains in active development, led by Gina. The ambitious suite of options bundled into OctoPrint have defined what 3D printer host software should include.

LIMITATIONS

While Gina has taken steps to keep OctoPrint tidy and responsive, recent projects such as AstroPrint (astroprint.com) are dedicated to optimizing a codebase for embedded computers, rather than the easy-to-collaborate path the OctoPrint community has followed. As a result, these other solutions (including 3DPrinterOS and Print to Peer) may run more efficiently on embedded hardware or offer greater customization (Figure C).

GETTING STARTED: OCTOPI

Grab the ready-to-deploy OctoPi SD card disk image maintained by Guy Sheffer (github.com/guysoft/OctoPi). Insert the card in your Raspberry Pi, follow the first-run installation wizard, and you'll be up and running with OctoPrint, its software dependencies, and automatic configuration of typical network and wi-fi tools, webcams and PiCams, and other resources.

BOTTOM LINE

With a passionate community, time, and money pouring into this well-respected open-source platform, OctoPrint is the tool to beat. Vendors such as Printrbot, Type A Machines, and DeltaMaker have taken to shipping embedded OctoPrint systems in their machines. ☑

+ Get started with this great video guide to OctoPrint on the Raspberry Pi: makezine.com/go/gsoctoprint

SHE BUILT THAT: GINA HÄUSSGE

Interview by Michel & Yves Sinner



● **Q: Describe OctoPrint to a noob.**
● **A:** It's like a mixture of a baby monitor and a remote control — you can control your printer but also see what is happening, and all that from within your browser.

● **Q: What led you to create it?**
● **A:** I had this shiny new 3D printer with its constant stepper motor sounds and molten plastic smells. The most important goal was really not wanting to have the printer in the same room as me but still be able to watch and monitor it constantly. And without having to strap a full-sized computer and loads of cables to it. And I wanted to be able to monitor the printer from any wi-fi-capable device, so making it all usable from a regular web browser was a top priority too.

● **Q: How will your employment at BQ impact OctoPrint?**
● **A:** BQ is a very open-source-conscious company and we fully agreed on OctoPrint staying open source under the same license. I'm now able to work full time on OctoPrint. I have a team contributing to the project and supporting the community, peers to bounce ideas off, quality assurance. We will see a lot of interesting development.

● **Q: What's your take on the integration of OctoPrint into printers?**
● **A:** It makes me proud. I find it very important, though, to not only take from the open-source community but also give back (by contributions but also always attribution). There are sadly always a couple of black sheep in the mix.

+ Read more: makezine.com/go/haussge

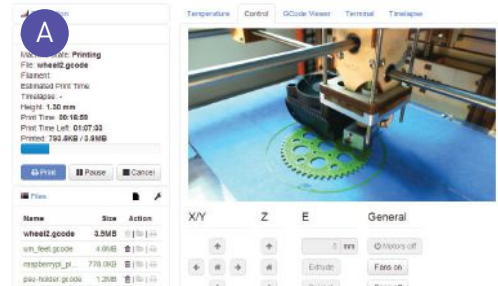

OctoPrint interface with webcam monitor activated during a print.

“IT'S LIKE A BABY MONITOR AND A REMOTE CONTROL FOR YOUR 3D PRINTER.”

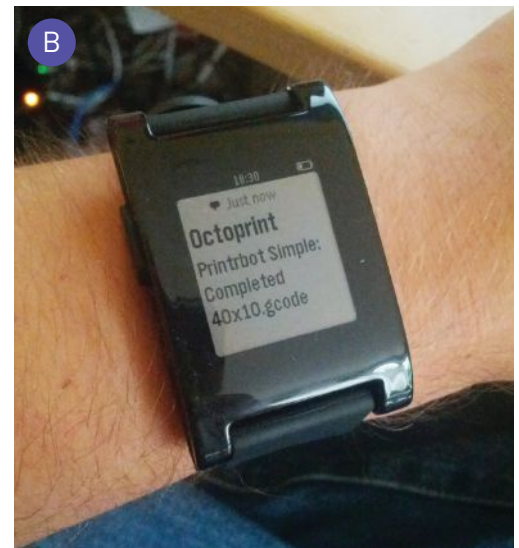

Jason Gullickson's OctoWatch Pebble project. github.com/jgg/octowatch.



AstroPrint interface on an iPad.

Nils Hitzte

Moritz Ulrich

Melinda Rainsberger

STICK IT FROM THE START

Win the print-adhesion battle

WRITTEN BY JOHN ABELLA



JOHN ABELLA is a maker of things, obsessive hobbyist, 3D printing and CNC enthusiast. Maker Faire New York 3D Printer Village wrangler and lead instructor at [BotBuidler.net](#), John has written for all three *Make*: 3D printer guides.

THE SINGLE GREATEST REASON FOR PRINT FAILURES

is a first layer that either wasn't laid down well or didn't stick to the platform. Here are the top tips from the *Make*: 3DP Test Team for getting that great first layer and making sure the print stays put.



thingiverse.com/thing:266543/RenatoT
Printed on an Ultimaker 2

1. First layer Z-height is key. The distance between the print bed and nozzle should measure about 50%-75% of your layer height. A sheet of regular 20# paper should just slide between with a small amount of friction.

2. Spend time leveling your print bed. It's important to get it right, and in most cases the settings will stay usable for a long time.

3. As you adjust layer height of your prints, your starting gap between the nozzle and the print surface may need to change. Prints at 60 micron layer height will need a smaller starting height than prints at 250 microns.

4. For ABS, a heated bed is required, but even the heated bed isn't foolproof. It's common to print onto either Kapton or PET tape, and increase stickiness by applying a mixture of ABS scraps in acetone or a few light coats of aerosol hairspray. Use only on a cold bed surface and away from any moving parts in your printer.

5. For PLA prints, we favor moving to heated beds, especially glass (clean, no fingerprints!), or any surface covered with blue painter's tape. For extra-large flat prints, wipe down the blue tape with 70% rubbing alcohol first.

6. Glue stick! We like the Elmer's brand that changes from purple to clear when it

dries. Apply a thin layer while the bed is cold.

7. Printing nylon? Use a Garolite (fiber-glass-epoxy laminate) bed. It's not a solution most people can pick up at the local big-box store, but it's widely available online. This material is sometimes referred to as "G10."

8. Try BuildTak (buildtak.com). It's a slightly textured plastic surface specifically created to increase print adhesion. These sheets are available die-cut for a number of different common printer bed sizes, work with both PLA and ABS, and provide peace of mind for overnight prints. ☺

RAINBOW EXTRUSION

Use Sharpies to snazz up your prints cheaply and easily

WRITTEN BY JOSH AJIMA

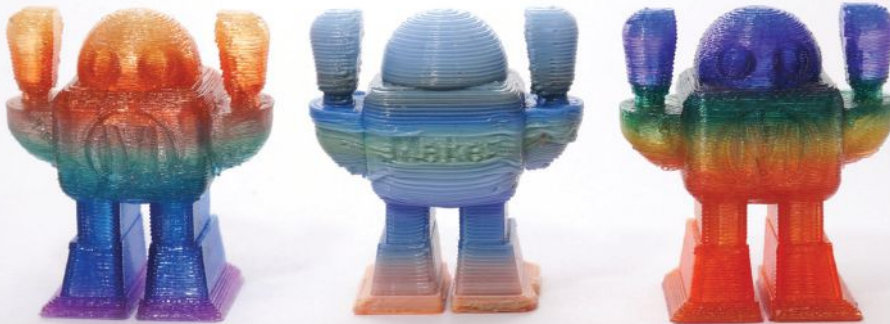

Anna Kazianus France

Time Required:
Approximately 1 Hour

Cost:
\$5-\$8

Materials

- » Transparent or white filament
- » Sharpie Permanent Markers, assorted colors
- » 3D printer

A QUICK AND CLASSROOM-SAFE WAY TO ADD COLOR TO YOUR PRINTS is using Sharpie markers to color transparent or white filament. While there are 3D-printable adapters that color filament as it enters the extruder, it's easy to color the filament by hand.

1. ESTIMATE FILAMENT LENGTH

To determine the length of the filament needed, slice your model with Cura (displays length in software) or Slic3r (look at last line of G-code). Or if your slicer can export standard G-code, upload it to gcode.ws, and the model info tab shows the length needed. The Makey robot should take around 800-1,500mm of filament.

2. COLOR

Divide the estimated filament length by the number of colors desired to determine the length of each colored section. Measure with a ruler and color as you go. Leave extra fila-

ment at the end in case your estimate is off. The first color fed into the extruder will be at the bottom of the model.

3. PRINT

Purge the extruder with transparent or white filament, then load the hand-colored filament. Pay careful attention when loading the filament and stop when you see the hand-colored filament coming out. Depending on your printer and slicer settings your print may require the first section of color to be longer to account for filament oozing/skirts/rafts at the beginning of the print. 🍌



Josh Ajima

10 GREAT SHORT PRINTS

WRITTEN BY
JOHN ABELLA

Fast demo prints in
30 minutes or less.



HAVING A WELL-TUNED PRINTER ALLOWS YOU TO PRINT LARGER AND LONGER — from overnight into

multiple days. Many of the printers we tested can easily take 40 hours or more to print items that max out their build areas. However, sometimes you just want fast prints for handouts, demos, or even while exhibiting at Maker Faire!

Here's the 3DP Test Team's curated list of fast prints that work well on any machine and take very little time.

1. STRETCHLET

thingiverse.com/thing:13505

2. ZOMBOE SNAKE

thingiverse.com/thing:4743

3. BOTTLE OPENER

thingiverse.com/thing:11025

4. CUSTOMIZABLE CARABINER

thingiverse.com/thing:57174

5. MINI WHISTLE

youmagine.com/designs/mini-whistle

6. MAKER FAIRE ROBOT

thingiverse.com/thing:40212

7. JORIS CUPS (SINGLE WALL)

thingiverse.com/thing:43914

8. FABERDASHERY SPINNING TOP

thingiverse.com/thing:193914

9. TINY MOBILE PHONE STAND

thingiverse.com/thing:330724

10. REBEL COIN FOR LAUNCHER

youmagine.com/designs/rebel-coin-for-launcher

Cyberpunk Spikes

3D-print these soft, flexible spikes and light them up with full-color programmable LEDs

Written by Becky Stern and Phillip Burgess

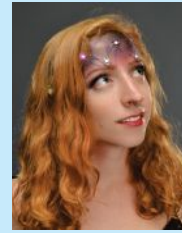

BECKY STERN
(adafruit.com/becky-stern) is a DIY guru and director of wearable electronics at Adafruit. She publishes a new project video every week and hosts a live show on YouTube.

Time Required:
A Few Hours
Cost:
\$70-\$85

Materials

- » NeoPixel RGB LED strip, 60 per meter, individually addressable Adafruit Industries part #1138, adafruit.com
- » NinjaFlex flexible 3D printing filament, Snow White Adafruit #1691
- » Adafruit Gemma microcontroller Maker Shed item #MKAD71, makershed.com, or Adafruit #1222
- » Slide switch, SPDT, 0.1" pin spacing Adafruit #805
- » Battery, LiPo, 500mAh Adafruit #1578
- » Battery extension cable, JST male-female Adafruit #1131
- » Rare earth magnets (6) Adafruit #9
- » Safety pins or needle and thread
- » Silicone adhesive, Permatex 66B
- » Heat-shrink tubing
- » Tape, nonconductive

Tools

- » 3D printer, fused-filament type
- » Computer running Arduino IDE software free download from arduino.cc/en/main/software
- » Soldering iron
- » Solder, rosin core, 60/40
- » Scissors
- » Wire cutters / strippers



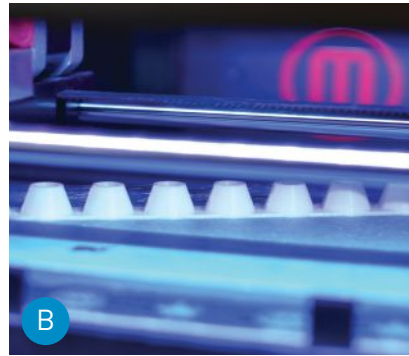

Becky Stern

MAKE YOUR OWN FLEXIBLE, SPIKY, GLOWING ACCESSORY USING NEOPIXEL LED STRIP

lights diffused by NinjaFlex flexible 3D printing filament! Magnets let you attach the spikes to anything in your wardrobe. The soft flexible enclosure holds Gemma, the tiny microcontroller that animates the LEDs, and a rechargeable lithium polymer battery.

We designed 2 styles of spike strip — one with regular round spikes and one crystal-inspired statement piece (Figure A). Whichever you choose, it'll get you noticed!

1. 3D-PRINT THE SPIKES AND ENCLOSURE

Download whichever spikes you like from thingiverse.com/thing:262494 and print them in NinjaFlex filament at 225°F with a nonheated build plate (Figure B). For more tips on working with NinjaFlex, check out the guide by the Ruiz Brothers at learn.adafruit.com/3d-printing-with-ninjaxflex.

Also download and print the 2 pieces of the flexible enclosure for the Gemma microcontroller and battery, from thingiverse.com/thing:262522. Since it's printed in NinjaFlex, the enclosure is soft and flexible, yet firm enough to protect your components (Figure C). The enclosure shape includes tabs for pinning or sewing to your garment.

2. PREPARE THE NEOPIXEL STRIP

Prepare the input end of your NeoPixel strip by tinning the pads with solder. The strip won't work if you solder wires to the wrong end, so be sure the arrows on the PCB point away from the end you're wiring.

Solder 3 stranded wires, about 8" long, to the tinned pads of the NeoPixel strip. To prevent the solder joints from being too cramped, solder the center pad's wire on the reverse side of the PCB as shown: 2 on top, one on bottom (Figure D).

Wrap 3 rare-earth magnets in tape to prevent

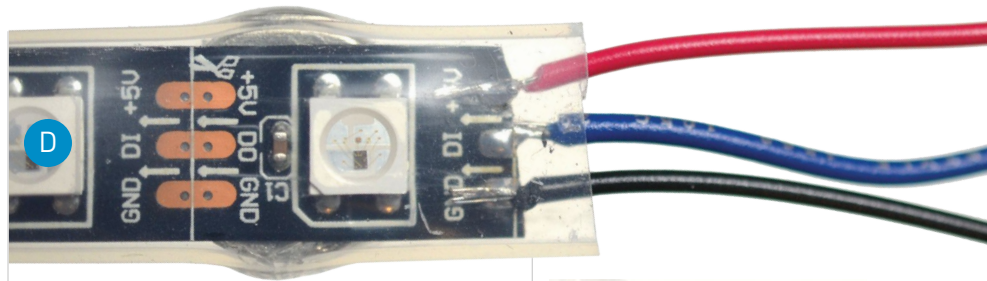

short circuits (Figure E), and slide them into the NeoPixel strip sheathing on the underside of the PCB (Figure F). Our spike strip is 16 pixels long, and we used 3 magnets evenly spaced (one at each end and one in the center).

Prepare a protected work surface in an area with good ventilation.

Use Permatex 66B silicone adhesive to affix the 3D-printed spikes to the NeoPixel strip (Figure G). Apply adhesive to both the strip's silicone sheathing and the NinjaFlex strip of spikes, using a toothpick to spread it around if necessary (Figure H).

Squish a bit of silicone adhesive into the ends of the NeoPixel strip sheathing to provide water resistance and strain relief (Figure I). Allow adhesive to dry overnight.

3. ASSEMBLE THE CIRCUIT

Route your NeoPixel strip's wires through the hole at the top of the enclosure (Figure J, on the following page), and solder them up to Gemma as follows: NeoPixel GND to Gemma GND; NeoPixel + to Gemma Vout; and NeoPixel signal to Gemma D1 (Figure K, following page).

Seat Gemma into the round outline inside the enclosure, with the USB port facing its opening at the bottom end of the enclosure (Figure L, following page).

Use a JST extension and slide switch to make this tiny adapter (Figure M, following page). Solder the connections as shown, and insulate with heat-shrink tubing.

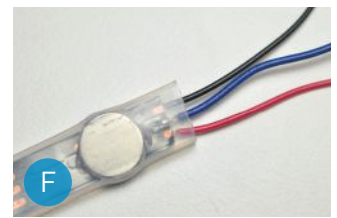

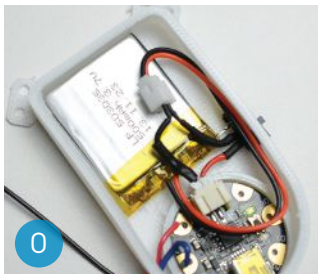
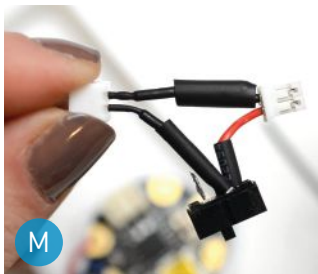
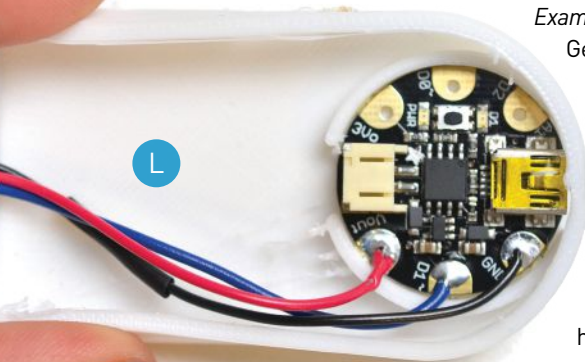
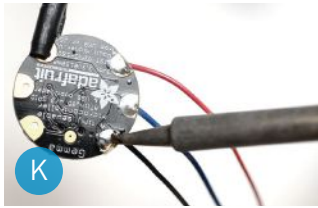
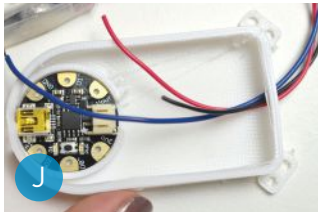

The slide switch fits into the opening in the enclosure (Figure N). Now you can easily power up your circuit while still making it easy to disconnect the battery for recharging.

Connect the battery, fit everything neatly in the enclosure (Figure O), and press on the lid.

4. LOAD THE CODE

Download the NeoPixel library from github.com/adafruit/Adafruit_NeoPixel. Rename the folder (containing the *Adafruit_NeoPixel.h* and *.cpp* files) to *Adafruit_NeoPixel* (with the underscore and everything), and place it alongside your other Arduino libraries, typically in your *[home folder]/Documents/Arduino/Libraries* folder.

Now open the *strandtest.ino* sketch from the *Examples* sub-folder, and upload it to the Gemma using the Arduino IDE.

Did that sound like gibberish to you? It's easy — if it's your first time, just read the "Introducing Gemma" and "NeoPixel" guides at learn.adafruit.com before you start.

The code is well commented to guide you through each part of the sketch and what it does. Let's have a look:

DECLARING AN OBJECT

All NeoPixel sketches begin by including the header file:

```
#include <Adafruit_NeoPixel.h>
```

The next line of code assigns a number to the symbol **PIN** for later reference. (This isn't necessary, it just makes it easier if you want to change the microcontroller pin where the NeoPixels are connected without digging deeper into the code.) Your strip is connected to Gemma's pin 1:

```
#define PIN 1
```

The next line declares a NeoPixel object:

```
Adafruit_NeoPixel strip = Adafruit_NeoPixel(16, PIN, NEO_GRB + NEO_KHZ800);
```

We'll refer to this by name later to control the strip of pixels. There are 3 parameters or *arguments* in parentheses:

- » The number of sequential NeoPixels in the strip, in our case **16**. (Yours might be longer.)
- » The pin to which the NeoPixel strip is

connected. Normally this would be a pin number, but we previously declared the symbol **PIN** to refer to it by name here.

- » A value indicating the type of NeoPixels that are connected. (You can leave this off; it's mainly needed for older NeoPixels.)

DEFINING COLORS AND BRIGHTNESS

The next block of code lets you define favorite colors, which the NeoPixel will call upon later:

```
// Here is where you can put in your
// favorite colors that will appear!
// Just add new {nnn, nnn, nnn}, lines.
// They will be picked out randomly
//
//           R   G   B
uint8_t myColors[][3] = {{232, 100, 255},
// purple
                        {200, 200, 20},
// yellow
                        {30, 200, 200},
// blue
                        };
```

There are 2 ways to set the color of any pixel. The first is:

```
strip.setPixelColor(n, red, green, blue);
```

The first argument — **n** in this example — is the pixel number along the strip, starting from 0 closest to the Arduino. If you have a strip of 30 pixels, they're numbered 0 through 29. It's a computer thing. (You'll see various places in the code using a **for** loop, passing the loop counter variable as the pixel number to this function, to set the values of multiple pixels.)

The next 3 arguments are the pixel color, expressed as numerical brightness levels for red, green, and blue, where **0** is dimmest (off) and **255** is maximum brightness.

An alternate syntax has just 2 arguments:

```
strip.setPixelColor(n, color);
```

Here, **color** is a 32-bit type that merges the red, green, and blue values into a single number. This is sometimes easier or faster for programs to work with; you'll see the *strandtest* code uses both syntaxes in different places.

You can also convert separate red, green, and blue values into a single 32-bit type for later use:

```
uint32_t magenta = strip.Color(255, 0, 255);
```

Then later you can just pass **magenta** as an argument to **setPixelColor** rather than the separate red, green, and blue numbers each time.

IMPORTANT: `setPixelColor()` does not have an immediate effect on the LEDs. To “push” the color data to the strip, call `show()`:

```
strip.show();
```

This updates the whole strip at once, and despite the extra step is actually a good thing. If every call to `setPixelColor()` had an immediate effect, animation would appear jumpy rather than buttery smooth.

The overall brightness of all the LEDs can be adjusted using `setBrightness()`. This takes a single argument, a number in the range 0 (off) to 255 (max brightness). For example, to set a strip to ¼ brightness, use:

```
strip.setBrightness(64);
```

ANIMATED EFFECTS

In the *strandtest* example, `loop()` doesn’t set any pixel colors on its own — it calls other functions that create animated effects. So ignore it for now and look ahead, inside the individual functions, to see how the strip is controlled.

You’ll see code blocks with parameters you can tweak to:

- » change the rate of twinkling
- » change the number of pixels to light at one time
- » transition colors gradually through the whole spectrum
- » display rainbow colors, static or animated
- » flash or fade random pixels.

5. WEAR IT!

You can stitch or pin the 3D-printed enclosure to your garment wherever you’d like, using the mounting tabs. For permanent use, stitch a pocket for this enclosure inside your garment and route the wires inside (Figure P).

» Use a fluffy bun-maker hair accessory and tuck the enclosure under it to wear these spikes around your head (Figure Q)!

- » Epaulets, two styles (Figure R and S).
- » Around the collar (see page 74).
- » Cyber dragon, anyone? Try the crystal-inspired spikes (Figure A, page 75).

How will you wear it? We’d love to see your variations! 🎧



P

NOTE: Since you sealed up the LED strip with adhesive, this accessory is fairly water-resistant. But turn it off and remove the battery if you get stuck in a torrential downpour!



Q



R

See more photos, and share your spike builds and costume ideas at makezine.com/projects/cyberpunk-spikes. This tutorial originally appeared on the Adafruit Learning System at learn.adafruit.com/cyberpunk-spikes.

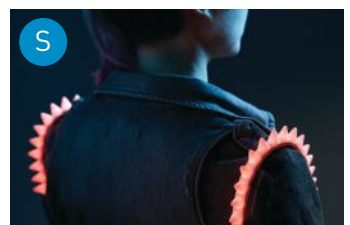

S

Time Required:
A Weekend

Cost:
\$5-\$50, and up

Materials

- » **Eyeglass lenses or 3D lens models** to design your frames around. You can 3D scan your existing lenses or download free lens models from eyewearkit.com.
- » **3D models of my frames (optional)** For a shortcut just modify the frames I designed. Grab the STL and Rhino files on the project page online.
- » **Screws, 2mm (2)**

Tools

- » **3D printer (optional)** If you don't have access, use a service such as Shapeways.
- » **Computer with CAD software** I used Rhino, free for 90 days from rhino3d.com.
- » **Digital camera or smartphone (optional)** if you want to 3D scan existing lenses
- » **Screwdriver**

3D Printed Eyeglasses

Finally! Design and print your own custom specs using these tricks.

Written and photographed by Aaron Porterfield



AARON PORTERFIELD

is a Bay Area-native industrial designer. His work crosses the borders between product design, parametric design, and digital fabrication.

HERE'S HOW I DESIGNED NEW 3D-PRINTED EYEGLASS FRAMES around lenses that can be made by any optometrist. Printing them on a MakerBot costs nothing compared to buying new frames.

I 3D-scanned my old lenses using my phone's camera and Autodesk's 123D Catch software (instructables.com/id/3d-scanning-a-glasses-lens). But it's easier to download 3D lens models from eyewearkit.com and design around those.

To make it even easier, just modify my 3D frames and save yourself a lot of design time!

1. PREP THE 3D LENS FILE

Scale the lens in your CAD program, using calipers or the width dimension stamped on your old frames, e.g., *50-18-135* means 50mm lens width, 18mm distance between lenses (DBL), and 135mm temple length. (If you downloaded a lens model, you can skip this.)

Offset the lens from your centerline by half the DBL (e.g., 9mm). Since glasses are symmetrical, you only have to model one half.

2. MATCH THE LENS CURVATURE

Orient the lens so that when mirrored it will have consistent curvature around your face. Draw that curve along the top surface, extending to your centerline.

3. DESIGN YOUR FRAME SHAPE

Offset your curvature line by the thickness of your lens, then offset each of those curves by 1.5mm–2mm to create the thickness of your frame (Figure A).

Here's the fun part: Draw the outline of your frame using 2 curves, top and bottom. Make a swept surface for each of those curves, then project your lens curve onto them (Figure B).

4. FIT YOUR LENS

My lenses have a V-shaped edge; I created a corresponding groove in the frame.

5. SURFACE YOUR FRAMES

Connect and fill in your frame surfaces. For the nose bridge, draw 2 curves to split the inside surfaces, then drag control points on those curves to shape the bridge (Figure C).

6. SHAPE THE TEMPLE ARMS

Draw the temple curves tangent to the frame, offset, and use frame edges as profile curves.

7. MODEL THE HINGES

I did a simple extrusion and Boolean union, sized for a 2mm screw (Figure D).

8. MIRROR

Mirror your model to make a pair of glasses.

9. PRINT AND ASSEMBLE

Stratasys Objet materials (shown here) have excellent resolution, but natural PLA is more durable. Most 3D printing services also offer an SLS nylon material, which should work well.

Finish your print to your liking by sanding or polishing. Then try pressing your lenses in. It was a very tight fit for me. (Optometrists warm the frames first, but I haven't tried that yet.)

Screw in your temple arms and enjoy! 🍷

Get the frame 3D files and complete step-by-step instructions at makezine.com/projects/3d-printed-glasses.

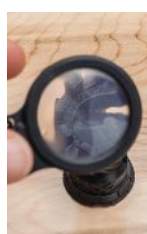
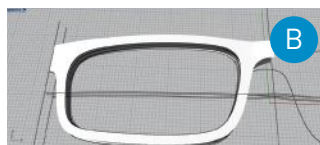
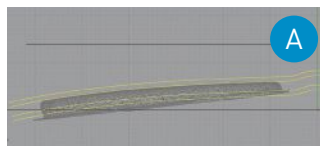

+ 3D-PRINTED LENSES TOO?

Formlabs has printed an optical lens in clear resin on their Form1+ SLA printer. Now we wonder: who'll be first to 3D-print complete prescription glasses? makezine.com/go/formlabslens

3D Medical Scan

Print Your

Prep CT images to print, using open-source software.

Written by Luis Ibáñez



LUIS IBÁÑEZ

(luis.ibanez@gmail.com) is a software engineer at Google and previously worked on an open-source platform for medical image analysis at Kitware.

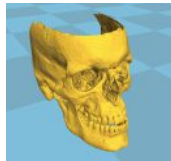

Jeffrey Braverman

SO YOU WERE IN AN ACCIDENT AND THE DOCTOR ORDERED A CT SCAN. Wouldn't it be cool to have a 3D-printed model of your own innards? In the United States, you have the right to this medical data under the HIPAA Privacy Rule. Ask for the digital data (rather than film prints), and you'll typically receive DICOM files.

Here's how to extract a 3D model for printing.

1. READING THE IMAGES

Image files from a 3D scan are typically saved as individual slices. Import your DICOM files into 3D Slicer using the menu File > Add Volume, then click "Load Selection to Slicer" to display the full set of images in a 4-quadrant window showing the X, Y, and Z slice cuts and a 3D view of the dataset.

2. SEGMENTING THE BONES

The process of extracting an anatomical structure from a 3D volumetric image is called "image segmentation." The easiest way to do it in 3D Slicer is the Region Growing tool: You choose "seed points" and the tool connects pixels having similar intensity values. Save your results to a new Volume.

3. GENERATING A SURFACE MESH

Next you need to extract the surface of the structure, in the form of a 3D mesh composed

of points and triangles connecting them. Using the Model Maker module, select your new Volume and save the resulting mesh as an STL file.

4. INSPECTING AND REFINING

Load the STL file into MeshLab to make sure the surface is properly constructed. If not, try again with 3D Slicer, increasing the Multiplier setting in the Region Growing tool (we used 3.5).

5. POST-PROCESSING

Meshes extracted from 3D images tend to have a very large number of triangles. To simplify the surface while preserving its general shape, apply the Decimate filter in ParaView and set the Target Reduction to 0.5 to reduce the number of triangles by 50%.

Using the Transform filter, rotate your model to fit on your printer bed. Remember, it comes from a real CT scan, so scale it down as needed.

6. 3D PRINTING

Load the refined STL file into your 3D printer's host program and slice it with Slic3r to generate G-code. Make sure to include supports, rafts, and infill so the model prints properly. Then, print it out! 🖨️

More details, complete step-by-step instructions, and screenshots at makezine.com/projects/3d-print-your-medical-scan.

Time Required:
A Weekend

Cost:
\$10-\$20

Materials

- » Your medical data in **DICOM format**, or try this free dataset from OsiriX instead: osirix-viewer.com/datasets/DATA/PELVIX.zip
- » **3D printer or printing service**
- » **Computer running free, open-source software:**
 - » **3D Slicer** (slicer.org)
 - » **MeshLab** (meshlab.sourceforge.net)
 - » **ParaView** (paraview.org)
 - » **Slic3r** (slic3r.org)

NOTE: Some body parts are too complex for FDM printers but feasible on SLS machines. The skull with a broken nose (left) of *Make*: executive editor Mike Senese was printed by Hawk Ridge Systems using a 3D Systems ProJet 660.

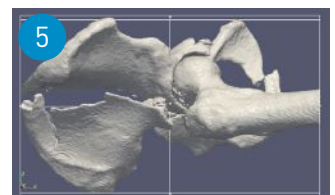
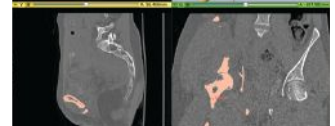
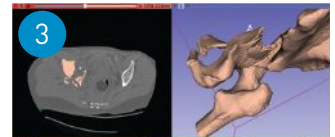

Time Required:
1-2 Days

Cost:
\$200 or Less

Written by Dan Spangler ■ Illustrated by Rob Nance

Boat Hitch Table

Make an adjustable-height modeling table like the pros, for hundreds less.

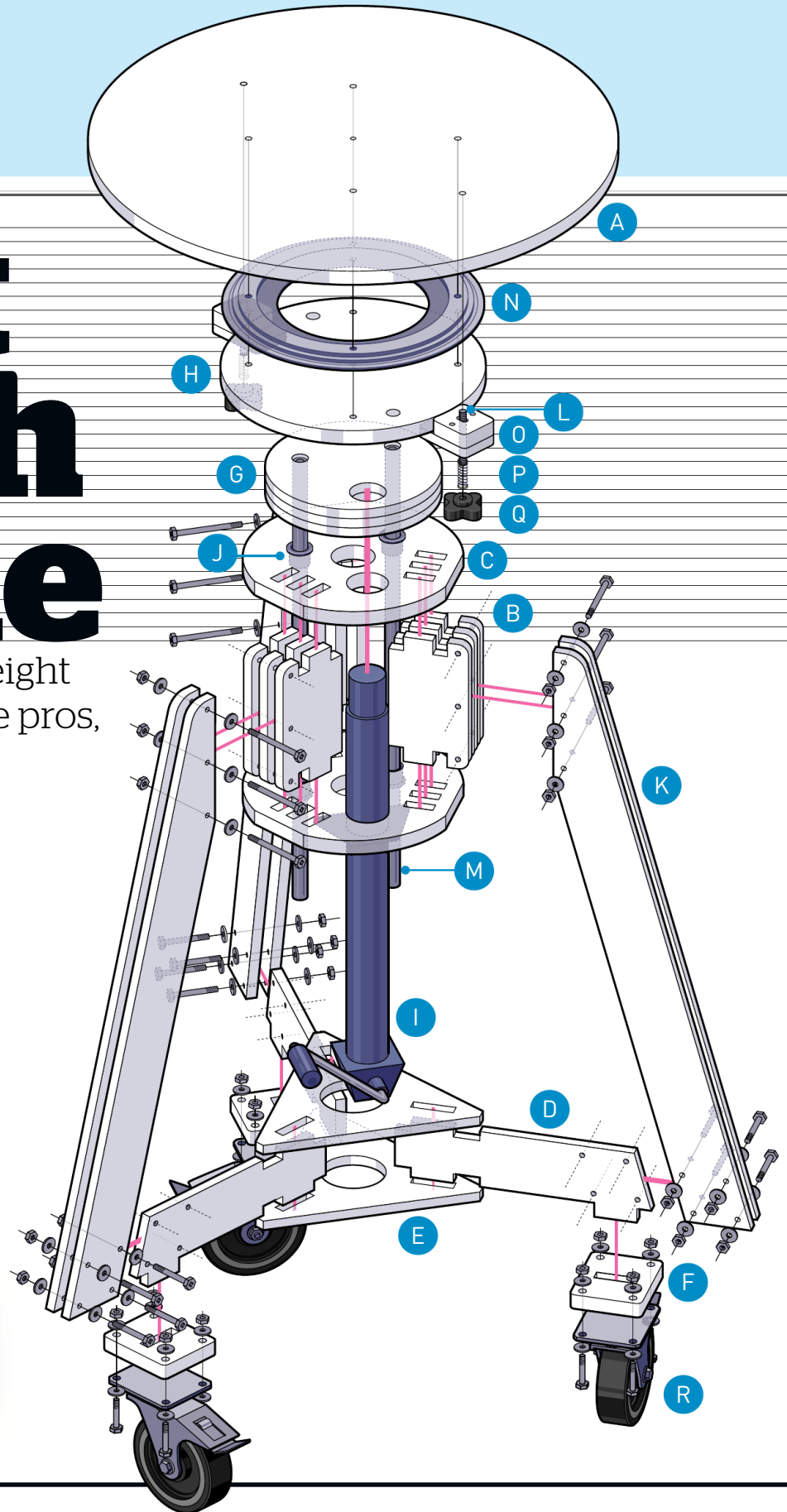

Gunther Kirsch

MY BOSS IS AN AVID SCULPTOR WHO LIKES TO RE-CREATE CHARACTERS AND MONSTERS from various games and comics. He wanted a new professional modeling table but didn't want to pay the \$800 price tag. So he asked me if I could make one for less than \$200.

I did, and I used a boat hitch jack to do it. The trick to a modeling table is that you can raise and lower the table surface, giving you better access to the underparts of your model when it's raised, and a more comfortable working position when it's lowered. Additionally, the tabletop needs to spin, and to support 200lbs — clay is not a light material.

I designed the table in 3D in Autodesk Inventor, then laid out the parts in 2D in AutoCAD for cutting on a CNC router. You can also cut it by hand. To finish it off, I added big 5" caster wheels so the boss can roll it around his cramped and messy shop without getting tripped up by stray clay stuck to the floor.

1. CUT THE PARTS. Download the part files from the project page makezine.com/projects/boat-hitch-table, and cut them on your CNC machine or by hand. Both 1/2" and 3/4" plywood are used, so make sure you're cutting the right thickness. All the cuts are through-cuts, except the tabletop **A** has six 1/2"-deep blind holes: Four are 5/16" diameter and the last two are 1/4".

2. TRIPOD HEAD. Glue the 9 tripod head bracket pieces **B** into their slots on the 2 tripod head plates **C**. Align the plates, clamp, let dry.

3. TRIPOD BASE. Glue the 3 tripod base boards **D** into their slots on the 2 tripod base plates **E**. Glue the caster brackets **F** to the ends.

4. TURNTABLE MOUNT. Stack and glue the 3 table mount discs **G** and lazy Susan adapter plate **H** as shown, taking care to line up all the holes on the table mounts.

5. JACK AND BEARINGS. In the bottom of the tripod head, slip the jack **I** through the medium-sized hole. Make sure the crank is facing outward, then clamp the jack in place and mark the jack's mounting holes onto the bottom of the tripod head. Remove the jack, drill 3 pilot holes, then fix the jack in place with 3/4"-long lag screws.

Press the flanged bronze bushings **J** into the 4 smallest holes in the tripod head as shown, with a dab of super glue or epoxy.

6. TRIPOD LEGS. Fit a pair of tripod legs **K** into the gaps of a tripod head bracket. Line up the holes and fix in place with the 1/4-20 x 3" screws, washers, and nuts. Repeat for all 3 brackets.

Now slot each tripod base board into its corresponding pair of legs, and bolt them with the 1/4-20 x 2" screws, washers, and nuts.

7. TABLETOP. Use a hex driver to screw the 1/4-20 threaded inserts into the 5/16" holes: 4 in the top of the turntable mount and 4 in the bottom of the tabletop. Epoxy the 2 threaded rods **L** into the 1/4" holes on the bottom of the tabletop.

8. GUIDE RODS. Carefully hammer the 3/4"x24" steel rods **M** into the 2 small holes on the bottom of the turntable mount.

Then carefully fit the steel rods into the bronze bushings in the tripod head. Guide the top piston of the boat hitch jack into the hole on the bottom of the turntable mount. Then, using a large steel mallet, hammer the piston into the hole.

CAUTION: Don't use a metal hammer directly against the ends of the steel rods. This will deform them and you won't be able to get them through the bronze bushings. Use a scrap of wood between the rod and the hammer to soften the blows.

9. TURNTABLE. Using 1/4-20 x 1/2" button-head cap screws, attach the 12" turntable **N** to the top of the turntable mount. Then attach the tabletop to the turntable.

10. TABLETOP BRAKES.

Glue together the 2 parts of the brake **O** as shown. Place a spring **P** onto one of the threaded rods on the bottom of the tabletop, then add the brake, and finish with a large threaded knob **Q**. Repeat for the other side.

11. CASTERS. Flip the whole table over. Bolt the large swivel casters **R** to the bottom of each tripod leg using four 5/16-18 x 1 1/2" bolts, washers, and nuts. Flip the table back onto its new casters. You're done!

The Boat Hitch Table can be used for any kind of sculpting, not just clay maquettes. It would also make a handy cake-decorating stand or stylish drink table. For version 2.0 I would definitely add some kind of plastic or metal surface to protect the tabletop, and a tool rack and tray for stray bits of clay and other things. And why not add strip lighting around the edge to illuminate the underside of the model you're making? 🌟

Download the 3D CAD files and CNC part files, and share your build at makezine.com/projects/boat-hitch-table.



DAN SPANGLER

is a freelance maker with a passion for fabricating speed, high voltages, and the things that go boom.

Materials

- » **Plywood:** 3/4" x 2' x 5' and 1/2" x 3' x 3' type of your choice
- » **Turntable, round, 12"** McMaster-Carr part #6031K19, mcmaster.com
- » **Flanged sleeve bearings, bronze, 3/4" ID, 1" OD, 1" long (4)** McMaster #6338K433
- » **Drive shafts, precision-ground steel, 3/4" diameter, 24" long (2)** McMaster #1346K32
- » **Knobs with 1/4-20 through hole (2)** McMaster #6092K11
- » **Trailer jack, A-frame mount, 1,000lb capacity** Surplus Center #1-3958, surpluscenter.com
- » **Swivel casters, with brake and swivel lock (3)** Surplus Center #1-3938
- » **Threaded inserts for wood, 1/4-20 thread, 33/64" long (8)** McMaster #92105A100
- » **Threaded rod, 1/4-20, 3" lengths (2)** aka all-thread
- » **Compression springs, approx. 1/2" diameter, 2" long (2)**
- » **Cap screws, 1/4-20: 3" (9) and 2" (12)**
- » **Cap screws, 5/16-18 x 1 1/2" (12)**
- » **Hex nuts: 1/4-20 (21) and 5/16-18 (12)**
- » **Washers, plain steel: 1/4" (42) and 5/16" (12)**
- » **Lag screws, 3/8" x 3/4" (3)**
- » **Socket head cap screws, 1/4-20 x 1/2" (8)**

Tools

- » **CNC router (optional)** If you cut by hand you'll need a drill, jigsaw or band saw, and a circular saw or table saw.
- » **Wood glue**
- » **Adjustable wrenches** aka Crescent wrenches
- » **Socket wrench set**
- » **Allen wrench set** aka hex keys
- » **Wood clamps**
- » **Steel mallet**
- » **Cordless drill and drill bits**
- » **Epoxy, 2-part**

DIY Pickles: Beets and Grapes

Quick and tasty, vinegar pickling is great for preserving a surprising variety of fruits and veggies Written by Kelly McVicker ■ Photographed by Wes Rowe

Time Required:
Grapes: 40 Minutes
Beets: 90 Minutes
Cost:
\$10-\$15



WHEN YOU HEAR THE WORD PICKLE, WHAT COMES TO MIND? A SALTY BRINED cucumber, slices of mango preserved in oil, or maybe a bowl of pungent kimchi? Pickling is a tradition found in virtually every culture on Earth. Mango pickles from India taste nothing like German sauerkraut, but the underlying process is the same.

Pickling transforms flavor and preserves food by raising the acidity to prohibit the growth of microorganisms that cause spoilage. The acid can be added in two ways:

FERMENTING — This involves adding salt and allowing the food to sit for a period of time, while beneficial bacteria transform natural sugars into lactic acid.

VINEGAR PICKLING — In this process, the acid comes from vinegar. Food is packed in a vinegar-based brine and allowed to sit for anywhere from a few hours to several months to achieve full flavor.

I learned vinegar pickling from my grandmas and my mom as a kid growing up in Kansas. Even though I've become increasingly enchanted with fermentation, I still turn to the vinegar method when I want to make several jars of the same thing and store them without refrigeration, whether for holiday gifts or just for stocking for my own pickle pantry.

Vinegar pickling usually gives more consistent results, since it quickly "shocks" the fruit or veggies to preserve them rather than waiting on the creation of new bacteria. And while vinegar pickling doesn't create probiotics, it does keep most of the nutrients intact. It's also more suitable for preserving foods without refrigeration — if you seal your pickles using the water bath canning process

Tools

- » Mason jars, pint or quart, with 2-piece lids
I recommend using button-top lids.
- » Medium saucepan
- » Measuring spoons

FOR CANNING BEETS:

- » Water bath canner or stockpot with metal rack large enough to cover jars with 2" of water
- » Canning tongs (optional)
- » Wide-mouth funnel (optional)
- » Lid lifter (optional)



KELLY MCVICKER

is the owner of McVicker Pickles, where she makes small batches using traditional recipes updated with new flavor combinations. Based in San Francisco, she also teaches hands-on workshops on pickling, mustard making, cocktail shrubs, and other home-friendly skills.

described in the recipe for Gingery Golden Beets below, you can store them at room temperature for up to a year.

I like these two recipes because they show just how far beyond cucumbers your pickling experiments can take you. The grapes are sharp and a bit spicy; the beets mildly sweet with a ginger-plus-vinegar tang. Both pair deliciously with creamy cheeses. I like to toss them both with some arugula, goat cheese, and a little vinaigrette made from the brine for a pickled salad snack.

SPICED PICKLED GRAPES

Grapes are perfect for pickling — firm and naturally acidic, with a soft skin that brine can permeate quickly. This recipe gives a deep, sweet flavor with surprising hints of savory from the garlic and bay leaf. Use Sichuan peppercorns if you can, for that special tongue tingle.

- » **3 lbs red seedless grapes, firm but ripe** such as Flame or Ruby
- » **1½ cups apple cider vinegar**
- » **1½ cups red wine vinegar**
- » **1½ cups water**
- » **1½ cups sugar**
- » **2 tsp salt**
- » **3 tsp Sichuan peppercorns or black peppercorns**
- » **3 tsp mustard seeds**
- » **2" piece of ginger, sliced thinly**
- » **2 garlic cloves, sliced thinly**
- » **3 segments star anise**
- » **3 bay leaves**

1. Remove all stems from the grapes. Rinse, pat dry, and set aside.
2. In a medium saucepan, combine vinegars, water, sugar, and salt and bring to a boil, stirring occasionally to dissolve. Reduce to a low simmer.
3. Distribute the spices evenly between the jars, except for a few pieces of ginger and garlic, and the bay leaves (Figure A).
4. Fill jars with grapes, taking care not to crush them, and leaving at least 1" of space at the top. Add the last pieces of garlic, ginger, and bay leaves around the outside of the jars (Figure B).
5. Pour hot brine over the grapes, submerging them all (Figure C).
6. Put lids on jars, then let cool to room temperature before refrigerating.
7. Let sit in the refrigerator 48 hours before tasting. These grapes will keep in the refrigerator for up to 2 months, their flavor intensifying with time.

GINGERY GOLDEN BEETS

Golden beets are milder than red ones. Because beets are dense and naturally low in acid, you'll take a few extra steps for pickling them. The water bath canning process creates a vacuum seal that makes the jars shelf-stable for a year.

- » **4 lbs small golden beets**
- » **3½ cups white vinegar**
- » **1½ cups water**
- » **1 cup sugar**
- » **2" piece of ginger, sliced very thinly**
- » **20 black peppercorns**

1. Bring a large pot of water to a boil. If you'll be canning your pickles, also bring a canning pot or another large stockpot to boil.
 2. Remove beet tops, then scrub clean. Cook beets in boiling water until tender enough to pierce with a fork, about 10–15 minutes. Drain and cover with cold water to stop the cooking.
 3. Combine vinegar, water, and sugar in a medium saucepan and slowly bring to a boil.
 4. Peel and cut beets into medium-sized cubes or ½"-thick rounds (Figure D).
 5. Pack the beets into clean pint-sized mason jars, leaving 1" of headspace.
 6. Pour the hot liquid over the beets, covering them completely but leaving ½" of headspace. Use a chopstick or other nonmetallic instrument to remove air bubbles, then add more brine if necessary to keep ½" of headspace (Figure E).
 7. Seal the jars. Wipe rim with a paper towel, center a clean flat canning lid on top, screw on the lid band, and tighten to resistance. Don't overtighten, or air can not escape during canning. (If skipping the canning process, refrigerate once the jars cool.)
 8. Using canning tongs or another heatproof utensil, put jars in a canner or a large stockpot with enough water to cover the tops by 1"–2". Boil 25 minutes (Figure F).
 9. Turn off heat and remove jars to cool to room temperature. After an hour, check for a seal by pressing down on the indentation in the middle of the lid. (If the button can be pushed down, the jar hasn't sealed — store it in the fridge and consume within a month.)
- Sealed jars will keep at room temperature for one year. After opening, refrigerate and consume within a month. ❏

See more photos and share your favorite pickle variations at makezine.com/DIY-Pickles.

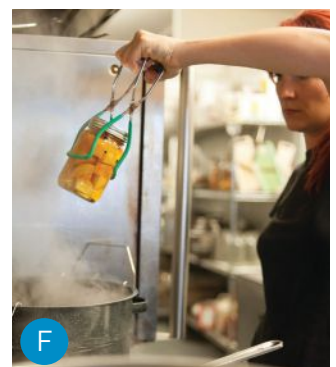

Dame Juliana Berners and the Fishing Lure

This 15th-century English nun wrote the book on the technology of recreational fishing.

Written by William Gurstelle ■ Illustrated by Nate Van Dyke



WILLIAM GURSTELLE

is a contributing editor of *Make* magazine. His new book, *Defending Your Castle: Build Catapults, Crossbows, Moats and More* is now available.

RECREATIONAL FISHING HAS BEEN AROUND FOR A LONG, LONG TIME.

Ancient writers Plutarch, Plato, and Aristotle, to name a few, make references

to this pastime. But the first real fishing guide, with instructions on how to make fishing tackle, was a straightforward little manual called *A Treatise of Fysshynge wyth an Angle*, published in 1496. Perhaps a bit surprisingly, its author was an English nun.

Dame Juliana Berners, prioress of the Priory of St. Mary of Sopwell, was the Ernest Hemingway of her day — she wrote about outdoorsy, adventurous subjects. She's best known for her DIY compendium on hunting, hawking (falconry), and emblazoning coats of arms, *The Boke of Saint Albans*, in which *Fysshynge* appears.

"Ye can not brynge a hoke into a fyssh mouth without a bayte," she begins, and then goes on in 25 pages or so to concisely explain how to use hand tools (*hamour*, *knyfe*, and *fyle*, for example) to make rods, line, and fishing lures. (You can read a modern English translation at flyfishinghistory.com/treatise_prologue.htm.)

There's little reliable information about Dame Juliana's life, and a few modern fishing historians are skeptical she actually wrote the book. But plenty of others are convinced she did, and so to her belongs the title of Mother of Recre-ational Fishing. Her work has influenced every major fishing writer from Izaak Walton to Gadabout Gaddis.

Time Required:
2 Hours
Cost:
\$5-\$10

Materials

- » Spoon, stainless steel flatware
- » Glass beads, $\frac{3}{8}$ ", red (2) or color of your choice
- » Steel bead wire, 24 gauge, 2' length
- » Split rings, size 4 (2)
- » Barrel swivel, size 10
- » Fishhook, treble, size 4

Tools

- » Hacksaw or rotary tool with abrasive cut-off wheel such as a Dremel
- » Center punch
- » Sandpaper, grinder, or rotary tool with grinding head
- » Drill press or hand drill
- » Vise
- » Drill bits: $\frac{1}{16}$ ", $\frac{1}{8}$ ", and $\frac{3}{16}$ "
- » Pliers, needlenose

GOIN' FISHIN'

How easy it is in our modern world to go fishing! Just visit a sporting goods store and head off to the lake. But preparing for a day of fishing was a complicated task in Dame Juliana's day.

First, you had to make a telescoping rod. Dame Juliana recommends hiking into the woods, preferably between the holidays of Michaelmas and Candlemas, to cut a staff of hazel, willow, or ash. Soak it in a hot oven and straighten it, dry it for a month, burn out a tapering hole using a red-hot roasting spit, then fit a smaller hazel rod within the tapering hole.

Making fishing line was even harder: Yank hair from a white horse's tail, weave it into a thin cord, and color it with dyes made from walnuts, soot, and ale. Thankfully, the section on how to make bobbers (floats) is quite simple, requiring only a cork and a quill.

Lure making, mostly tying flies, concludes Dame Juliana's *Treatyse*. Her descriptions of 12 different artificial flies — yellow flies, stoneflies, wasps, and drake flies, to name a few — provided centuries of fisherfolk with excellent advice on making lures that actually caught fish.

THE LURE OF MAKING LURES

Few modern makers would invest the time and effort to wind their own line out of linen or carve a rod from wood. But making one's own lure is an altogether different story. Lure making is straightforward, and just imagine the satisfaction — and bragging rights — that come from catching a trophy fish on a self-made lure.

The key to a successful lure is to mimic the motion of bait animals:

A jig is a weighted hook made to bounce or "jig" at the end of a fisherman's line.

A plug is an irregularly moving lure in the shape of a small fish.

And a fly is a tied and feathered hook that alights at the water's surface like a bug, as discussed in Dame Juliana's treatise.

Among the most popular modern lures is the spoon — a concave metal oval with a hook at the back. Spoons dart and wobble as they're pulled through the water, exciting game fish and enticing them to bite.

Spoons were not known to Dame Juliana — fishing historians credit J.T. Buel of Castleton, Vt., with designing and crafting the first spoon lure in about 1820. Apocryphally, at least, Buel came up with the idea when he saw a large fish swallow a spoon he accidentally dropped into a lake.

MAKING A SPOON LURE

You have a great deal of latitude in choosing spoon size and shape, hook size, and so on. This version is big enough for bass and pike; make a smaller one for pan fish.

1. CUT THE SPOON

Use the hacksaw or cut-off wheel to remove the spoon's handle or stem (Figure 1a).

Remove the burr from the cut (Figure 1b) using the grinder or rotary tool (easier), or sandpaper (harder). Sand the edge smooth.

2. DRILL THE SPOON

Mark the locations for the 2 eye beads on the concave side of the lure. Clamp the spoon in a vise and use the steel center punch to make an indentation on your marks.

Next, drill a $\frac{1}{16}$ " pilot hole for each eye bead (Figure 2a). It can be difficult to drill through the spoon with a hand drill because the bit will tend to wobble. Take your time and apply minimal pressure while starting the hole. Change bits and enlarge these holes to $\frac{1}{8}$ ", then $\frac{3}{8}$ ".

Drill $\frac{1}{16}$ " holes above and below each eye bead hole, for the attachment wire.

Drill $\frac{1}{8}$ " holes at each end of the spoon, for attaching the hook and leader (Figure 2b).

3. ASSEMBLE THE LURE

Seat the eye beads in the $\frac{3}{8}$ " holes and fix them in place with the bead wire. Insert the wire through a bead and both of its $\frac{1}{16}$ " holes, and then pull taut and tie off (Figure 3a).

Attach #4 split rings to the hook hole and the leader hole.

Attach a #4 treble hook to the split ring in the hook hole.

Attach a #10 barrel swivel to the split ring in the leader hole (Figure 3b).

GONE FISHING

Remember, the idea behind any successful lure is to make the fish think the lure is something good to eat. You can change the lure's movement through the water by using a hammer to make it more or less concave, or by slightly bending the leading or trailing edge of the spoon. You also can add feathers or colors if you think it will make the lure more attractive.

You're ready to catch some fish! 🐟

See more photos and share your DIY fishing lures at makezine.com/dame-juliana-berners-and-the-fishing-lure.

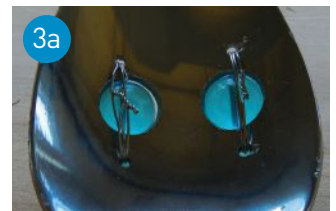

Time Required:

1-2 Hours

Cost:

\$85-\$200

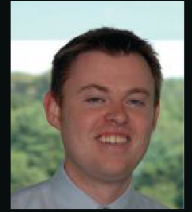

DAVE CONROY

is a Boston-based Northeastern University grad who has a true passion for all things tech. @conroydave daveconroy.com

Universal Translator

Speak and be spoken to – translate between thousands of language pairs with voice recognition, using the Raspberry Pi. Written by Dave Conroy

Materials

- » **Raspberry Pi single-board computer** Maker Shed item #MKRPI2, makershed.com
- » **SD Card, 4GB or more** Get a Pi and 8GB card bundled, Maker Shed #MKRPI4 or MKRPI5. Or get more goodies in the Raspberry Pi Essentials Kit, #MSRPIESS, or Raspberry Pi Starter Kit, Maker Shed #MSRPIK or RadioShack #277-196.
- » **USB headset** such as RadioShack #43-256
- » **Battery pack, 4xAA, with USB socket (optional)** for portable operation, RadioShack #270-087
- » **Wireless USB network adapter (optional)** aka wi-fi dongle, for portable operation. Get it in our Pi-Fi Bundle, Maker Shed #MSBUN65; or separately, RadioShack #25-2966.
- » **USB keyboard** Any will do, but check out our Pimoroni accessory kits, Maker Shed #MKPMR06 and MKPMR07.

Tools

- » **HDMI monitor** for interfacing with the Raspberry Pi
- » **Computer with internet access** for establishing free online accounts needed to interact with the Universal Translator

IF YOU'VE EVER TRIED TO COMMUNICATE WITH SOMEONE WHO ONLY SPOKE A FOREIGN LANGUAGE, YOU KNOW IT CAN BE EXTREMELY DIFFICULT — even with the help of modern translation websites. In this project you'll turn a \$39 mini-computer into a feature-rich language translator that supports voice recognition, native speaker playback, and thousands of language pairs. The unbelievable part is that it can all be done on the cheap by leveraging inexpensive hardware, free translation APIs, and some open-source software.

The Universal Translator works by recording a spoken phrase using a headset and the Raspberry Pi mini computer **A**. It then converts it into text using Google's API for speech recognition **B**. This text is fed into Microsoft's translation API **C** where it is translated into the desired language and then turned back into speech once again. The Raspberry Pi then plays the translated phrase back to the user through the headset **D**.

The Universal Translator is a perfect weekend project that will teach you how to use some very powerful tools to create something immediately useful. Oh, and it's a *blast* to play with. Here's how it's done:

1. INSTALL FREE SOFTWARE ON THE PI, including MPlayer and FLAC to handle sound files and Libcurl to transfer files.

2. CONFIGURE THE USB HEADSET as the Pi's audio input and output device.

3. DOWNLOAD AND EXTRACT THE PROJECT CODE: a shell script and 2 Python scripts. It's free on Github (github.com/dconroy/PiTranslate), and you can use and modify it as you wish.

4. REGISTER ONLINE FOR GOOGLE SPEECH AND MICROSOFT TRANSLATION APIS at cloud.google.com/console and datamarket.azure.com/developer/applications. Then enter the API keys into their respective Python scripts.

5. USE IT! By default, the Translator translates English to Spanish. You can easily change your origin and destination languages in the last line of *text-to-translate.py* and the script will do the rest. Execute the speech-to-text script:

```
./stt.sh
```

Now speak into the headset — *"My hovercraft is full of eels."* — and press Ctrl-C when done.

The Pi displays feedback on the command line — *Translating 'my hovercraft is full of eels'.* — and then speaks the translation in your headset:

"Mi aerodeslizador está lleno de anguilas."

Enjoy! 🍷

Get complete instructions, code, and video on the project page: makezine.com/projects/universal-translator.

1 2 3

Board Feet

Written by Sean Michael Ragan ■ Illustrations by Julie West

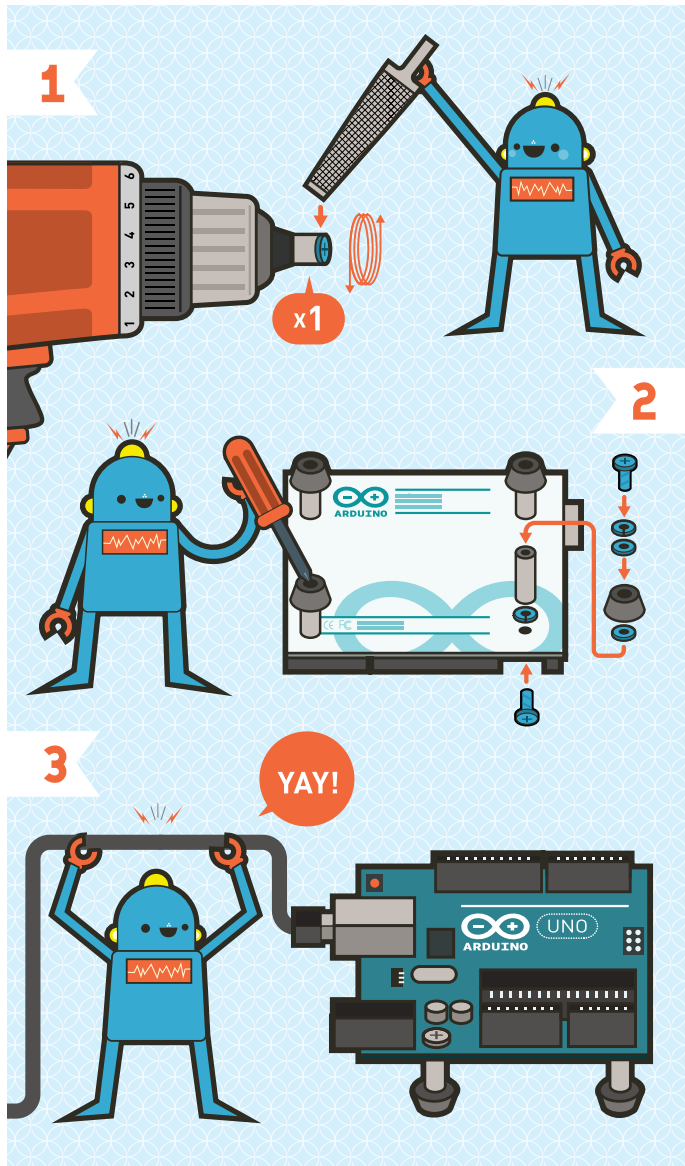

WHEN WORKING WITH ARDUINO AND OTHER BOARDS, most people just set the bare PCB down on the bench, hook up cables and components, and go. As long as your benchtop isn't made of metal, and you're careful, this can work fine. But it's not ideal. Clipped leads and other metal junk can short across the exposed solder points, causing erratic behavior and even damage. Give your board a lift by adding legs built from off-the-shelf hardware.

1. MAKE A SPECIAL SCREW

(Arduino only) The Uno REV3, Mega, and other Arduino boards have a minor design flaw in the mounting hole nearest the USB port — the nearby pin headers are too close to clear any standard screw head. » To fix, just turn one of your screws tightly into one end of a loose standoff, wrap the standoff in electrical tape to prevent marring, and chuck it into a handheld drill or drill press. » Fire up the drill, then use a small file (with one face taped to make it "safe") to turn down the screw head to 0.175" / 4.4mm or so.

2. MOUNT THE STANDOFFS

Pass four screws through the mounting holes from the component side. » Slip a lock washer over the threads on the solder side, then add the standoffs and tighten down.

3. INSTALL THE FEET ON THE STANDOFFS

Put a lock washer, then a flat washer over the threads of each of four screws before passing it through the recessed bumper from the bottom. » Add a second flat washer on top of the bumper, then thread the screws into the free ends of the mounted standoffs. » Tighten securely, and you're done! 🔩

Check out step-by-step photos at: makezine.com/projects/board-feet



SEAN MICHAEL RAGAN

(smragan.com) is a writer, chemist, and longtime *Make* contributor. His work has also appeared in *ReadyMade*, *c't - Magazin für Computertechnik*, and *The Wall Street Journal*.

You will need:

- » **Development board with 3+ mounting holes** such as Arduino Uno, BeagleBone Black, etc.
- » **14mm × 8mm recessed rubber bumper (4)** Uxcell #A11120700UX0247
- » **M3 × 10mm F/F threaded hex standoff (4)** McMaster-Carr 92080A110
- » **M3 lock washer (8)** McMaster-Carr 9111A118
- » **M3 × 8mm JIS pan head Phillips machine screw (8)** McMaster-Carr 94102A103
- » **M3 flat washer (8)** McMaster-Carr 93475A210
- » **Phillips head screwdriver**
- » **Electrical tape**
- » **Drill**
- » **File**

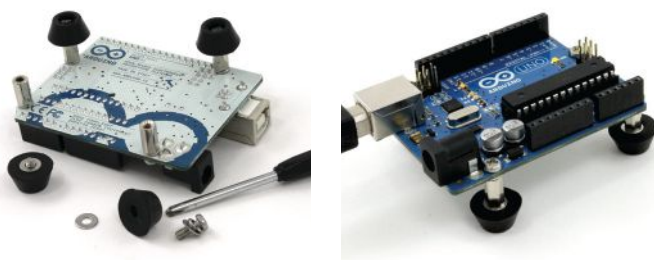

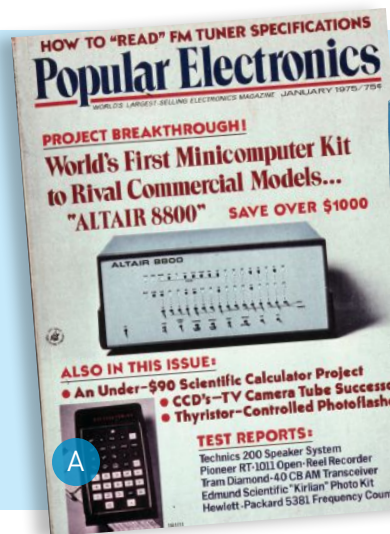

Smithsonian

The Kit That Launched the Tech Revolution

On the 40th anniversary of the Altair 8800 microcomputer: 1975-2015.

Written by Forrest M. Mims III

PERSONAL COMPUTERS, LAPTOPS, AND TABLETS WERE ONLY A DREAM IN 1975. Back then electronics hobbyists were mesmerized by the January 1975 issue of *Popular Electronics* magazine (Figure A). The cover showed a metal box with rows of toggle switches and LEDs under a label that read "Altair 8800." Boldly printed over the photo were these words: "Project Breakthrough! World's First Minicomputer Kit to Rival Commercial Models." Though primitive by today's standards, the Altair 8800 is widely credited with jump-starting the personal computer era.

The Altair was developed by Micro Instrumentation and Telemetry Systems (MITS), a nearly bankrupt company in Albuquerque, New Mexico. The company's president and chief engineer was the late Ed Roberts (Figure B), a non-sense visionary who had dreamed of building his own computer since high school.

MITS and *Popular Electronics* come to mind every time I browse *Make*: magazine. Will something as revolutionary as the Altair 8800 someday emerge from these pages? Perhaps the Altair story will inspire you to transform your dream into the next big thing.

THE MITS STORY

MITS was founded in 1969, when Robert Zaller, Stan Cagle, and I met at Ed Roberts' house in Albuquerque (Figure C) to form a company to manufacture a model rocket light flasher that I had described in the September 1969 *Model Rocketry* magazine (Figure D). That article began my career as a writer, but Ed had much bigger ambitions.

After we sold only a few hundred rocketry gadgets, we decided to try something new during the summer of 1970. That spring I had written my first article for *Popular Electronics*, a feature on LEDs. When I asked if they'd like an LED light wave communication project and kit to accompany the feature story, the answer was yes. Ed and Bob designed a prototype we called the Opticom that could send voice up to 1,000 feet. *Popular Electronics* published both articles in November 1970.

I soon left MITS to become a full-time writer. Ed stayed

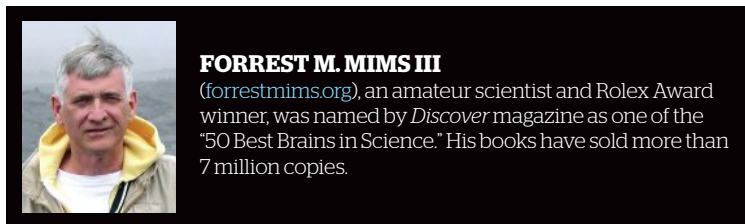

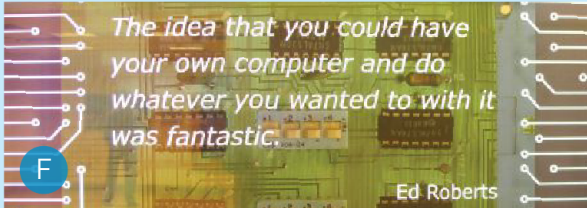

Minnie Mims

on to develop calculators. His article about the MITS 816, the first digital calculator kit, also made the cover of *Popular Electronics*. All went well until serious competition arrived from Japan. MITS was nearly bankrupt by 1974.

That summer MITS' *Popular Electronics* connection would come to the rescue. The cover story of the July 1974 *Radio-Electronics* magazine, *Popular Electronics*' main competitor, was a breakthrough project: the Mark-8, a DIY microcomputer designed by Jonathan Titus around Intel's 8008 8-bit microprocessor. The article offered a manual and a printed circuit board but not a complete kit. Nevertheless, the Mark-8 lit the rivalry fuse.

THE ALTAIR 8800

Popular Electronics editor Art Salsberg and technical editor Les Solomon knew that Ed Roberts and MITS engineer Bill Yates were working on a microcomputer project using a more advanced processor, Intel's new 8080 chip. They agreed to publish a major cover story.

One evening Ed called to ask if I would stop by to see the first prototype, so I hopped on my bicycle and rode the five blocks to MITS. Ed and Bill were standing by a metal box about the size of a thick briefcase on a workbench. Its front panel was lined with rows of switches and LEDs. Hanging from the wall were Bill's intricate layout patterns for the PC boards inside the box.

Ed invited me to take a close look, then asked: "How many do you think we'll sell?" Based on sales of MITS model rocket gear, the Opticom, and the calculators, I was not optimistic that a bare-bones computer would do much better. So I said a few hundred at most.

Ed was disappointed by my response, for he was confident the computer would easily sell in the hundreds. But we were both wrong. In the months following the Altair 8800 article in *Popular Electronics*, MITS sold thousands of assembled and kit Altairs, even though the early models had only 256 bytes of RAM and no keyboard or monitor beyond their front panel switches and LEDs. The price of the basic kit was \$439, around \$1,925 in today's dollars.

DIY ALTAIRS AND OTHER VINTAGE COMPUTERS

The Altair 8800 lives on in pampered working versions cared for by enthusiastic computer historians, engineers, and hobbyists. You can share their passion for the earliest days of personal computing with replica Altair kits, PC boards, and assembled versions available online.



Classic computer collector Rich Cini designs replica PC boards of early computers, including the Altair 8800. He has also developed an Altair emulator that programmers will find interesting (classiccmp.org/altair32). Cini highly recommends S100computers.com and the N8VEM Home Brew Computer Project (makezine.com/go/n8vem). These sites specialize in PC boards compatible with the S-100 bus that Ed Roberts designed to interconnect the boards of the original Altair 8800.

Grant Stockly (altairkit.com) and Mike Douglas (altairclone.com) sell Altair replica kits complete with custom-made cabinets carefully copied from the original Optima housing. Douglas' price is notable in that it's identical to the original MITS price — \$439 — even though a dollar in 1975 equals around \$4.50 today.

THE ALTAIR'S LEGACY

Computers require a language and programs. Paul Allen knew that very well when he spotted the Altair on the cover of *Popular Electronics* at Out of Town News, a Harvard Square newsstand. He bought the magazine and hurried to the Harvard dormitory where his friend Bill Gates (Figure E) resided. Allen and Gates soon contacted Ed Roberts, and the collaboration that followed resulted in the founding of Microsoft. MITS was their first customer.

Ed's Altair and Microsoft's version of the BASIC programming language ignited the revolution that soon led to the personal computers introduced by Apple, RadioShack, IBM, and a host of other firms. The Altair's role is not forgotten. The one Ed gave me for writing the Altair manual is now in the Smithsonian.

LEARN MORE

- » "The Altair Story: Early Days at MITS" by Forrest M. Mims III, *Creative Computing*, November 1984, makezine.com/go/cc-altair
- » *Idea Man* by Paul Allen, reviewed in *Make*: Volume 27, makezine.com/review/startups
- » StartUp Gallery (Figure F) at the New Mexico Museum of Natural History and Science in Albuquerque, startup.nmnaturalhistory.org. At the grand opening of StartUp (Figure G), Minnie Mims photographed Paul Allen (right) and MITS founders Ed Roberts (seated), Forrest Mims (left), and Robert Zaller. 📷

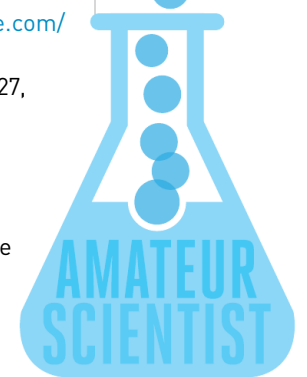

Make-an-Entrance Party Doorbell

Let your guests choose their own sound effects, using clever wireless sensors and a Raspberry Pi. Written by Matt Richardson



MATT RICHARDSON (matrichardson.com) also wrote the feature "Raspberry Pi Inside" on page 26 of this issue. His books *Getting Started with Raspberry Pi* and *Getting Started with BeagleBone* are available at makershed.com.

NEXT TIME YOU HOST A PARTY, LET YOUR GUESTS CHOOSE WHAT KIND OF ENTRANCE TO MAKE!

The Make-an-Entrance Party Doorbell is a wireless doorbell with four buttons. Your guests can select between themes you choose, say, royal fanfare, heavy metal, *Star Trek*, or cheering sports fans. When they push a button, a regular doorbell sound is heard inside. But when the door is opened, a fun sound effect is played to match their selection.

At the core of the project is a Raspberry Pi equipped with the EnOcean Sensor Kit. This kit is neat because it allows you to use wireless sensors and buttons that don't require batteries. The kinetic energy exerted to press the doorbell button is used to send a wireless signal to the Raspberry Pi to select the sound effect. A solar-powered contact sensor then signals the Pi that the door has been opened, prompting the Pi to play the appropriate sound.

Changing the entrance themes is as easy as changing WAV files and updating a dry-erase board. Your friends will always look forward to making an entrance at your next party.

1. SET UP THE TRANSCIVER MODULE AND FHEM SERVER. The EnOcean transceiver plugs into your Raspberry Pi's I/O pins. Update the Pi software and firmware as described on the makezine.com project page, then install FHEM, the open-source home-automation web server.

2. TEST FHEM. Find your Pi's IP address, then open your computer's web browser to <http://<RPi-IP-Address>:8083/fhem>. You're looking at the FHEM web server on your Pi. Test the EnOcean switches and you'll see their statuses change on the web page. Cool!

3. DOWNLOAD PROJECT CODE AND SOUND FILES. The Python source code will connect to FHEM via telnet and process all the actions that FHEM detects from the EnOcean Pi module. You just need to find 4 fun WAV files for sound effects, plus a fifth for the doorbell sound. Freesound.org is a great resource.

4. INSTALL THE SENSORS. Stick the EnOcean kinetic switch to the dry-erase board with mounting tape and decorate according to your themes. Attach the contact sensor to the door frame, and its magnet to the door.

5. FINISHING TOUCHES. Edit your Pi's crontab to launch the party doorbell script on reboot. Remove your keyboard, mouse, and monitor, and plug your sound system into the Pi's analog audio output. Your Make-an-Entrance Doorbell is ready to party. 🎉

Get complete instructions, code, and video on the project page: makezine.com/projects/make-an-entrance-party-doorbell

Time Required:
1-2 Hours
Cost:
\$140-\$200

Materials

- » **Raspberry Pi single-board computer, Model B or B+** Maker Shed item #MKRPI2 or MKRPI5, makershed.com, running the latest version of Raspbian and connected to the internet
- » **SD Card, 4GB or more** Get a Pi and 8GB SD card together, Maker Shed #MKRPI4 or MKRPI5. Or get more goodies in the Raspberry Pi Essentials Kit #MSRPIESS, or Raspberry Pi Starter Kit #MSRPIK.
- » **EnOcean Pi RF Module** from Element 14 at element14.com. Choose the 902MHz version for U.S.A./Canada, 868MHz for Europe/China, or 315MHz for Asia excluding China.
- » **EnOcean Sensor Kit** from Element 14. The kit includes kinetic pushbutton switch module, and solar-powered magnetic reed switch and temperature sensor modules. Again, choose 902MHz, 868MHz, or 315MHz.
- » **Spare rocker plate for EnOcean kinetic switch** Get a second kit, or 3D-print your own plates following the guide at makezine.com/go/enOcean-rocker.
- » **USB power supply**
- » **Computer speakers or sound system**
- » **Mounting putty**
- » **Dry-erase board, small (optional)** for the doorbell sign. Feel free to be creative with other materials here.
- » **Mounting tape**

Tools

- » **USB keyboard** such as Maker Shed #MKPMR06 or MKPMR07
- » **USB mouse**
- » **HDMI monitor with audio capabilities**
- » **Computer**



1

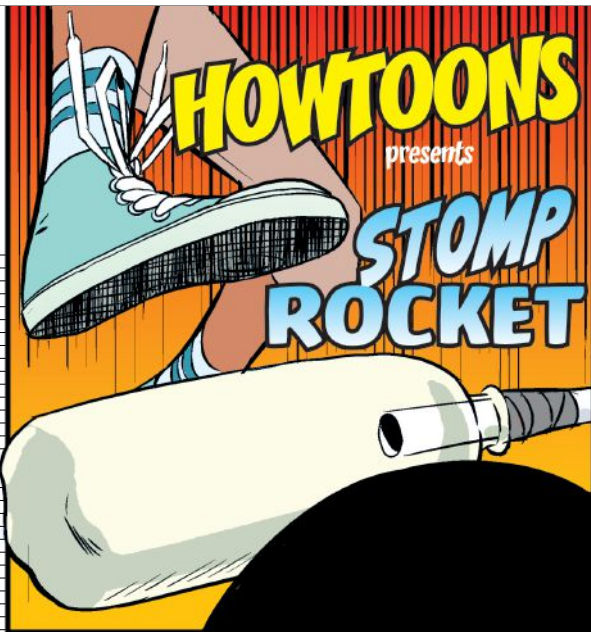

MAKE THE ROCKET:

ROLL 8-1/2" X 11" PAPER AROUND 1/2" PVC PIPE.

SECURE ROLLED PAPER WITH TAPE.

PULL PIPE OUT, THEN PUSH EDGES DOWN TO SEAL ROCKET TOP.

SECURE TOP WITH TAPE.

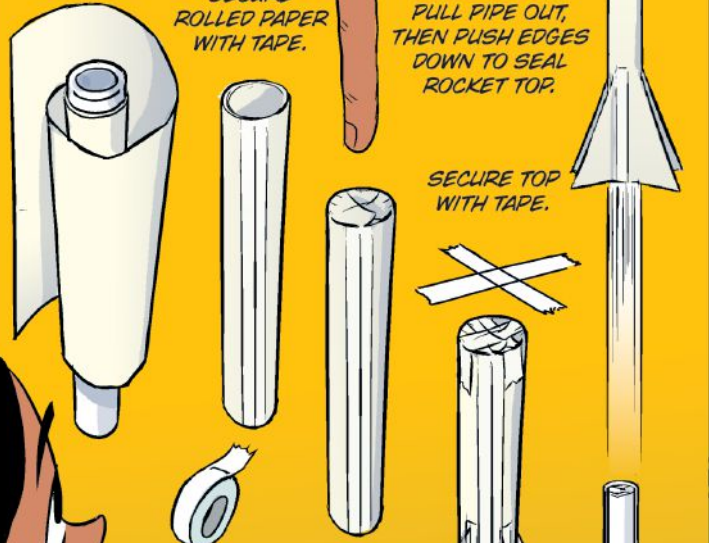

ROCKET FINS:



CUT 4 TRIANGLES OUT. CUT AND FOLD FLAPS FACING OPPOSITE DIRECTIONS. TAPE FLAPS TO ROCKET BASE.

LAUNCHER BASE:

CONNECT 1/2" PVC PIPE AND FITTINGS TOGETHER. ATTACH THE SODA BOTTLE TO THE END OF THE PIPE. SECURE AND SEAL WITH DUCT TAPE.

24" PVC PIPE

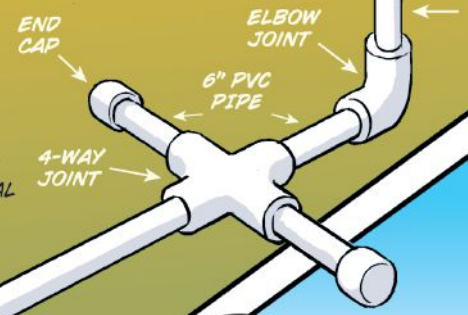

I'VE GOT IT!

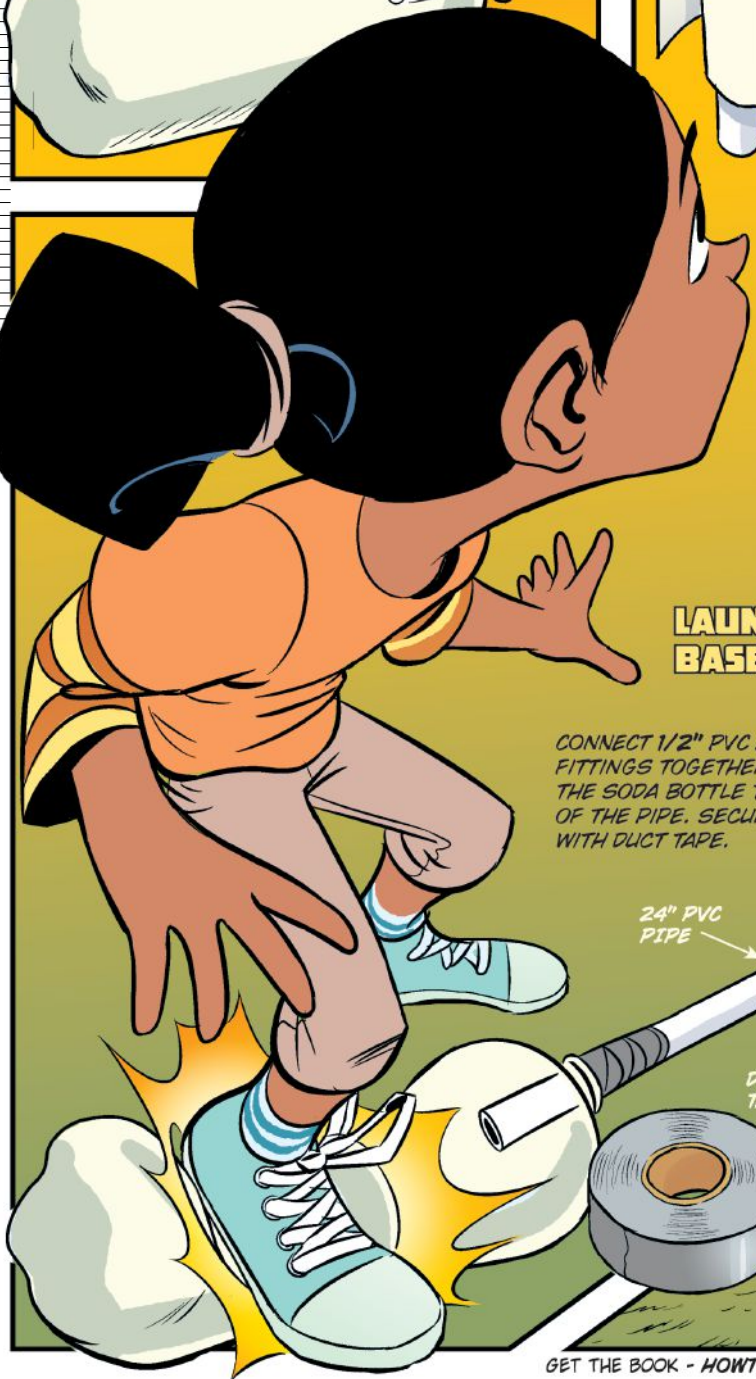

Toy Inventor's Notebook

COLORFUL COMIC KALEIDOSCOPE

Invented and drawn by Bob Knetzger

Materials

- › PETG Tube-Pak with vinyl end caps, 1¼" diameter
TAP Plastics #30245
- › ABS plastic sheet, black: 1⅛" × 6½" strips (3) and 1⅜" diameter disk
- › LED, RGB
RadioShack #276-016
- › Button cell battery, 3V
- › Button cell battery holder
- › Momentary switch, SPST

Tools

- › Cutting/drilling implement
- › Super glue

ORDINARY KALEIDOSCOPIES MUST BE POINTED TOWARD A LIGHT SOURCE TO WORK. This one has built-in illumination, so you can hold it right up against a printed page. The RGB LED's color-changing feature continuously cycles through a rainbow of colors, making viewing black-and-white comics a trippy treat!

Make the body from a 1¼"-diameter Tube-Pak cut to 6½" length. Cut 3 strips of thin black ABS, 1⅛" wide and 6½" long. Arrange with long edges together and the shiny sides facing in to form a triangular shape. Insert into the tube to create a great front-surface mirror kaleidoscope.

Cut a 1⅜"-diameter disk out of ABS and make a ¾" hole in the center. Drill 3 small holes near the edge and thread the LED's legs through. Bend the legs to ensure the LED will shine inside the mirrors when the disk is in place. Then attach the SPST momentary switch to same side of the disk with super glue.

Wire the LED's flat-side lead to ground of a 3V button cell battery holder and wire the center leg to positive. Then wire the switch between the third LED leg and ground. Press the button to turn on the LED and then cycle through its modes, the last of which is auto cycle.

Cut a 1⅜" hole in the center of both caps. Make a hole for the switch button in the side of one cap, and then make a matching notch in the end of the tube. Position the disk with the LED in place inside, and slip the battery between a mirror and the tube. Slide the cap on, with the switch poking through the small hole and aligned in the notch. Put the other cap on the opposite end. If needed, cover the back and side of the LED with a bit of black electrical tape to shade your eye from glare. ☑

To see a demo video and to share your comic creations with us, visit makezine.com/colorful-comic-kaleidoscope.

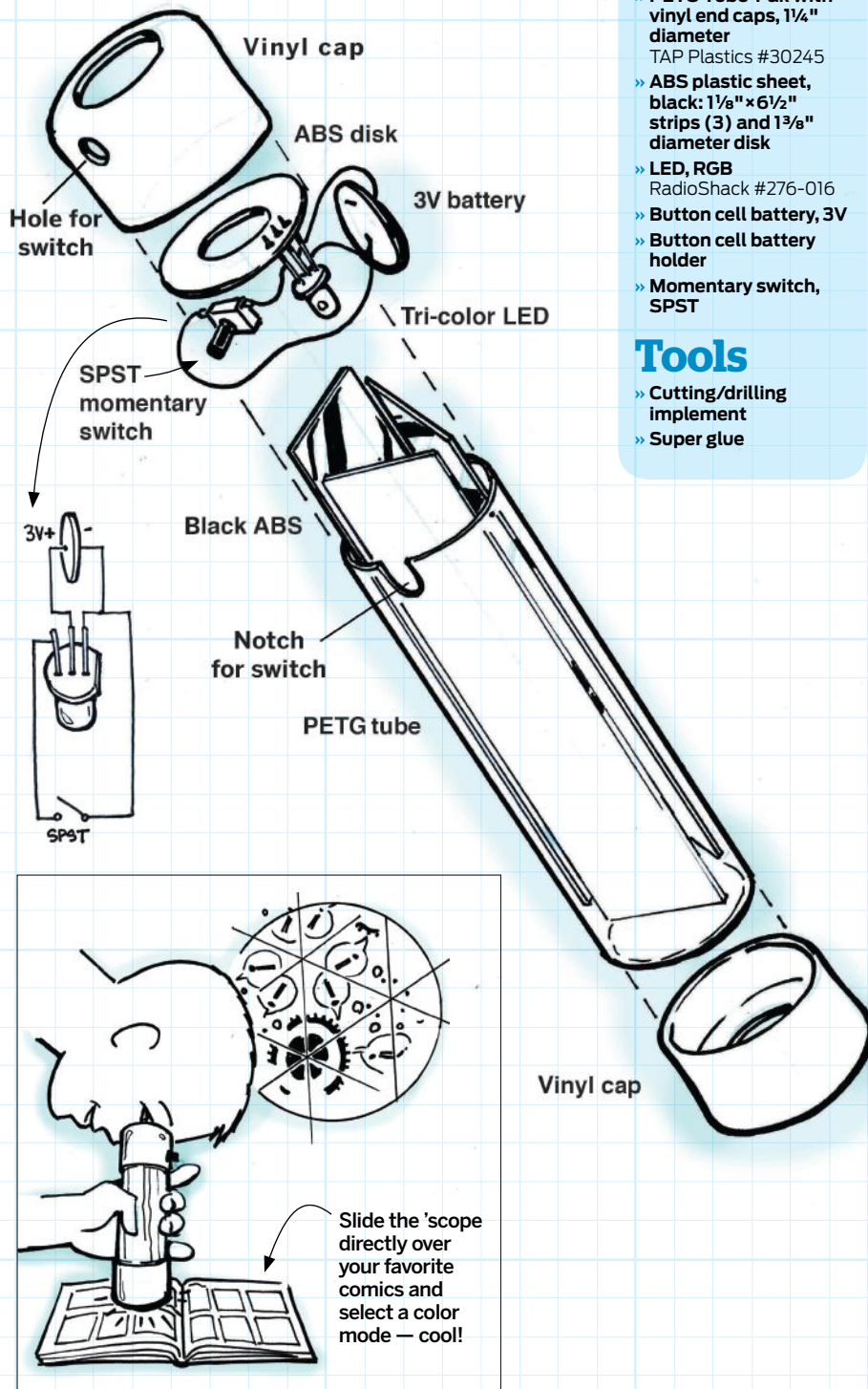

Slide the 'scope directly over your favorite comics and select a color mode — cool!

QUITE A FINE FOURSOME



Make: magazine's team put these four through rigorous review. Now available in the Maker Shed.



Ultimaker 2
MAKERSHED.COM/ULTIMAKER2



LulzBot TAZ 4
MAKERSHED.COM/LULZBOTTAZ4



MakerBot Replicator, 5th Generation
MAKERSHED.COM/MAKERBOT5



Printrbot Metal Simple
MAKERSHED.COM/PRINTRBOTSIMPLE

>MAKERSHED.COM

Maker Shed

The official store of **Make:**

EASY

GLOWING RECOMMENDATIONS

Written and photographed by Charles Platt

Vintage components that add character to your creations.

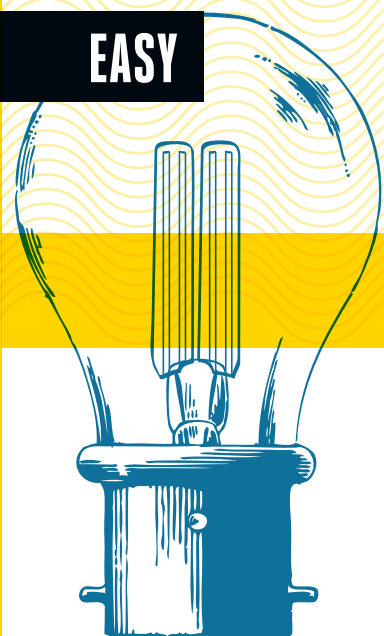

CHARLES PLATT

is the author of *Make: Electronics*, an introductory guide for all ages. He has completed a sequel, *Make: More Electronics*, and is also the author of Volume One of the *Encyclopedia of Electronic Components*. Volumes Two and Three are in preparation. makershed.com/platt

CONSIDER THAT HUMBLE DEVICE, **THE DIGITAL ALARM CLOCK.** It does its job, telling the time with four simple digits, but it doesn't have a whole lot of soul. This is why handmade Nixie-tube alarm clocks still sell to collectors: The glow from a gas-discharge tube is supernaturally special compared with that weary workhorse of digital electronics, the seven-segment numeric display. People enjoy funky-looking retro gear that has character. If it glows in the dark, so much the better.

Light-emitting devices have been on my mind, lately, as I've been writing about them in the *Encyclopedia of Electronics*, Volume Two (to be published in time for Christmas, I hope). Digging around in parts catalogues and in my own basement, I came across oddball displays and indicators that could give any new project some geek appeal. I'm talking about the kind of thing that makes someone stop and say, "Wait a minute. What is that?"

Intensely Incandescent

Long ago, miniature light bulbs fulfilled the function that is now served by LEDs. Surprisingly, those baby bulbs are still available, for a wide variety of voltages, for less than \$1 in some cases. The sample in Figure **A** is super-tiny, only 3mm in diameter, terminating in two little pins that you can insert into a breadboard. The bulb in Figure **B** is of similar size, with thin wire leads. Or you can choose a screw-in base, as shown in Figure **C**, allowing easy replacement if the bulb burns out. All three of these incandescent indicators run on 5VDC (or 5VAC — they're not fussy).

They draw slightly more current than an LED, and may be rated for 25,000 hours instead of 50,000. But they don't need series resistors, there's no polarity to worry about, and the pale yellow radiance is special.

Search an online catalogue for "incandescent" and you'll find all kinds of goodies.

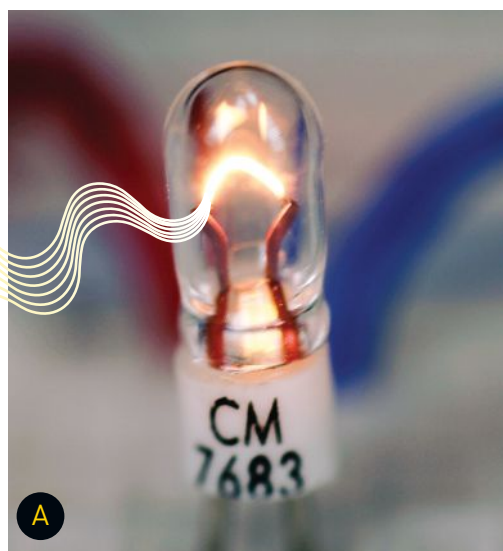

Chicago Miniature Lamps part #7683. 5V, 60mA, rated 25,000 hours.

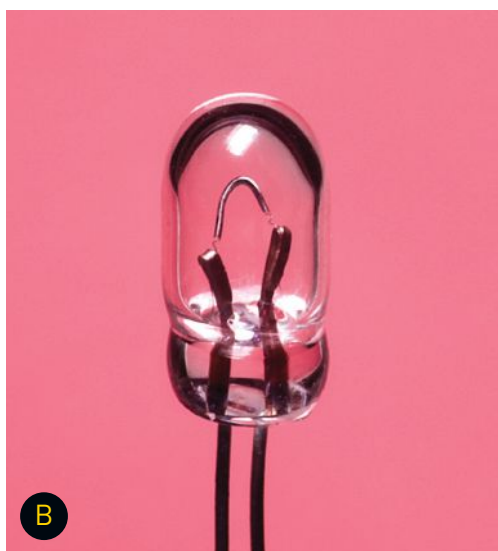

JKL Lamps #683. 5V, 60mA, rated 100,000 hours.



C

JKL Lamps #7319. 5V, 115mA, rated 40,000 hours.

Nicer in Neon

The word *neon* may make you think of Las Vegas, but I'm still thinking about indicators. A neon bulb is a gas-discharge tube in which a relatively high voltage (80V and up) ionizes the gas, emitting photons. Neon bulbs aren't super-bright, and their discharge comes in only one color (orange), but that's part of the retro appeal. You can buy tiny ones, or medium-size ones, or full-size light bulbs containing electrodes in fanciful shapes — like the one in Figure D, which I picked up at a yard sale. The little lamp in Figure E is more practical, about a quarter-inch in diameter, sold with a series resistor preattached. It needs 110VAC but draws hardly any current, and it can be switched with the smallest available 5VDC solid-state relay.

Exercise caution with 110 volts: One wiring error will zap your digital components instantly, and can also zap you.

Nine Segments Too Many

While seven-segment LEDs manage to do a minimal job of displaying numerals, they were never intended for letters of the alphabet. Manufacturers responded to this need by adding extra segments — but 16-segment alphanumeric LEDs were so ugly, few people wanted to look at them. Consequently they are now almost obsolete, which makes them a great nostalgia item. The

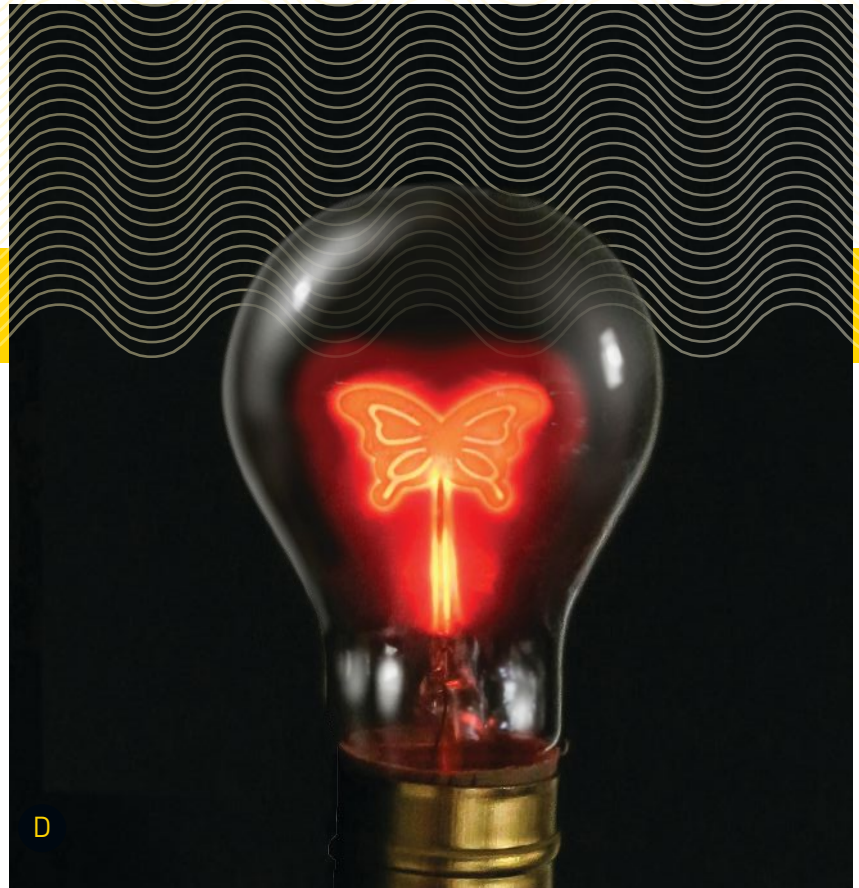

D

Although neon lamps with ornamental electrodes aren't being made anymore, the old ones last for decades.



E

Sorenson #9950-X-00-00000-0002. 125V max, other details unavailable.

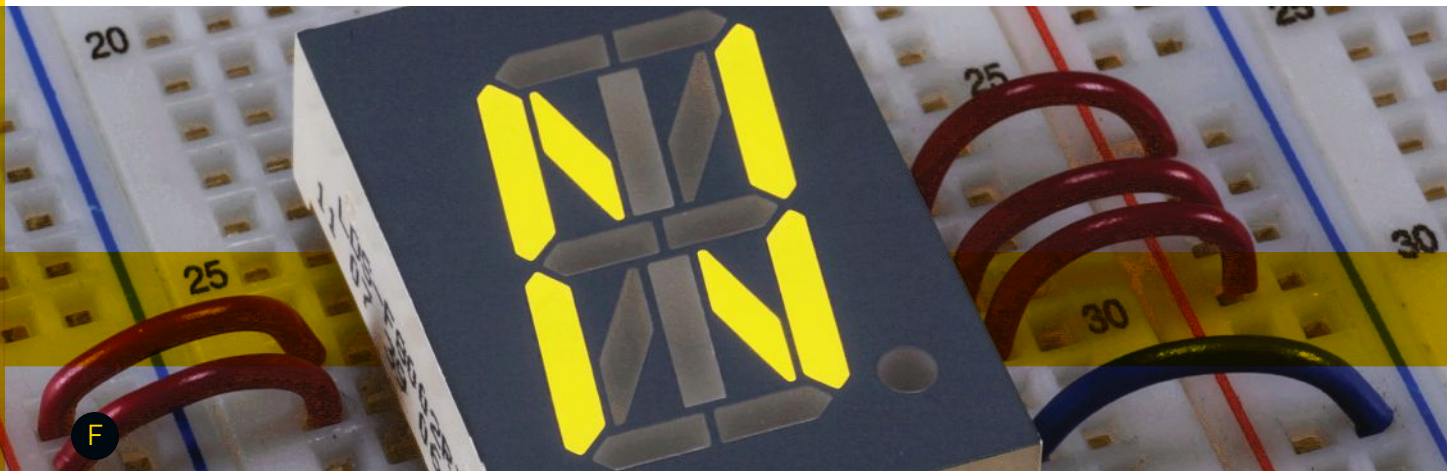

0
1
2
3

Lumex LDS-F8002R1. 2.2V typical forward voltage, 25mA typical forward current.

display in Figure **F**, pictured while attempting to represent the letter N, is 0.8" tall. If you put eight of them together you can multiplex them through a controller chip such as the Maxim MAX6954, which has a 16-segment alphabet stored in ROM.

Imagine a fortune-telling toy that offers its advice from a random selection of single words, using creepy green 16-segment displays that are sooooo 1990s. Maybe you can arrange for some of the segments to malfunction, creating a flickering effect that is tantalizingly ambiguous. What did it just say? Was it HOPE, or NOPE? Or maybe COPE?

Consider adding a vibration sensor so that if you bang on the box, the display will stabilize itself momentarily. Building a retro device that pretends to malfunction can open up a world of possibilities.

Pimp My Chip

The TIL311 is a numeric LED display designed by Texas Instruments back in 1972. Send it a binary number from 0000 through 1001 and its internal logic generates a decimal digit from 0 through 9. Current-limiting for the LEDs is built in, no decoder is needed, and there's no tricky serial communication protocol. Just drive its four inputs directly from a counter chip or a microcontroller, and you have an instant no-hassle numeric output. If you really want to geek out, the chip can represent hexadecimal values by using letters A through F.

It generates decent-looking dot-matrix characters (as shown in Figure **G**), and its body is molded from translucent red plastic, revealing the conductors inside. With gold-plated pins, it has a pimped-out look, like cheap jewelry. Just the thing for wearable electronics.

D4

D5

D6

2R2

U
122

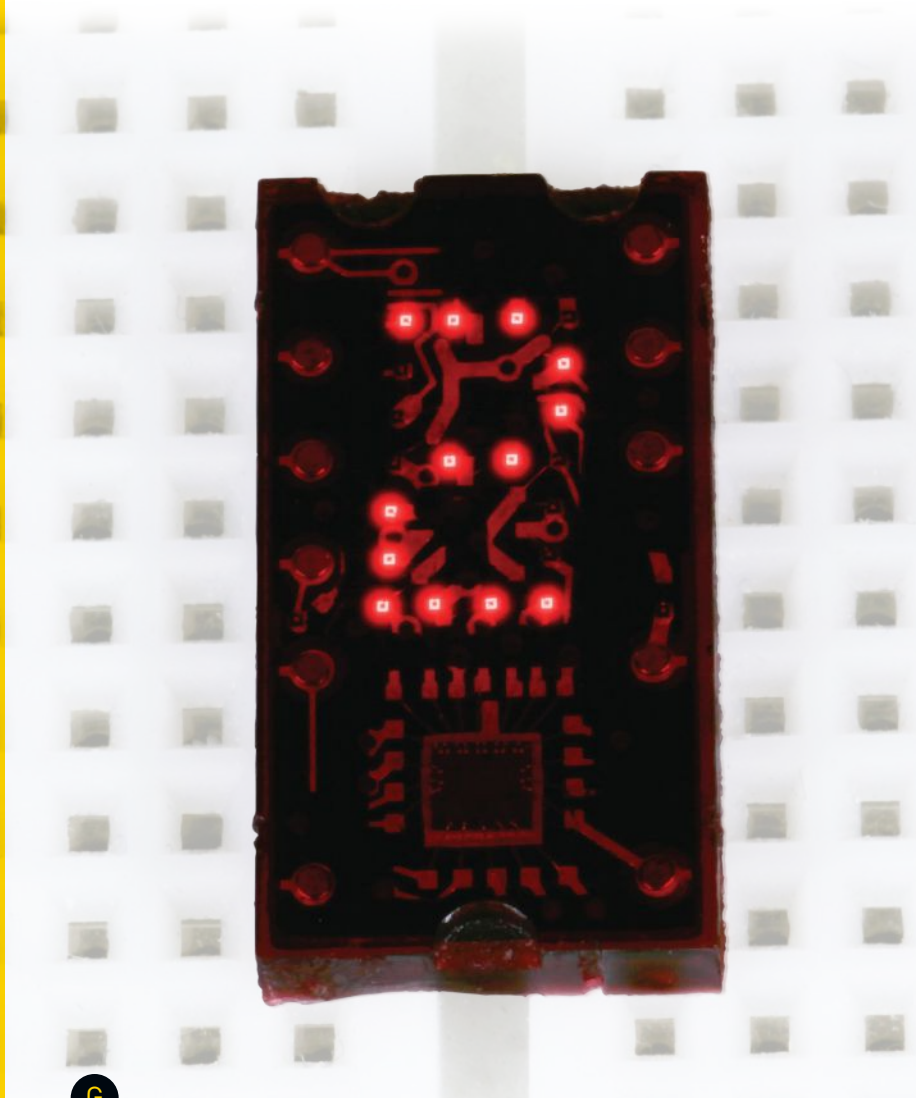

Texas Instruments TIL311. 5VDC. Total supply current for logic plus LEDs: typically about 100mA.

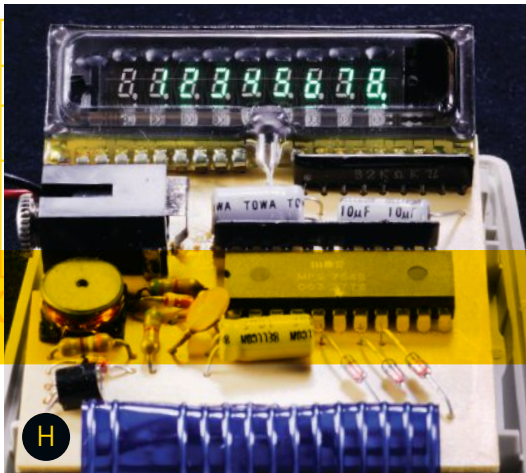

H

Commodore electronic calculator, model 7980.

5

Because TI doesn't make it anymore, it has become a scarce and coveted item, with U.S. suppliers charging a minimum of \$20 apiece for old stock. Fortunately you can find them on eBay from Asian sources at one-quarter the price. I have to wonder how those funky old chips ended up in China. Maybe they were pulled from trashed 1970s minicomputers. I just bought a bunch of them, and I think you'll find there are still a few left, at least for now.

Fluorescent Digits

Around 1973 my father acquired one of the first Commodore calculators. I ran across it recently, opened it up, and was blown away by its trippy little vacuum fluorescent display (VFD), shown in Figure H. Nine tiny digits reside in a sealed capsule, proudly made in Japan. (In those days, China was still ruled by Chairman Mao, and was barely capable of building houses, let alone manufacturing electronics.)

74M

1

2

3

6

4

The display probably takes about 20V, but the keypad interfaces with the calculating chip using 5VDC. So, you could repurpose it as an output display for a microcontroller. Just follow the conductors from the keys to the chip, cut the traces, and make new connections. And if you didn't share my good fortune of inheriting a vintage digital artifact from your dad, you can find them online for maybe \$5 each. Most are not considered collectible (yet), despite the totally cool '70s styling shown in Figure I.

I'll bet you can think of some other idiosyncratic indicators to add pedigree to your next project. No matter what you build, it will surely benefit from the mystique of light-emitting technology that is almost, but not quite, obsolete. ●

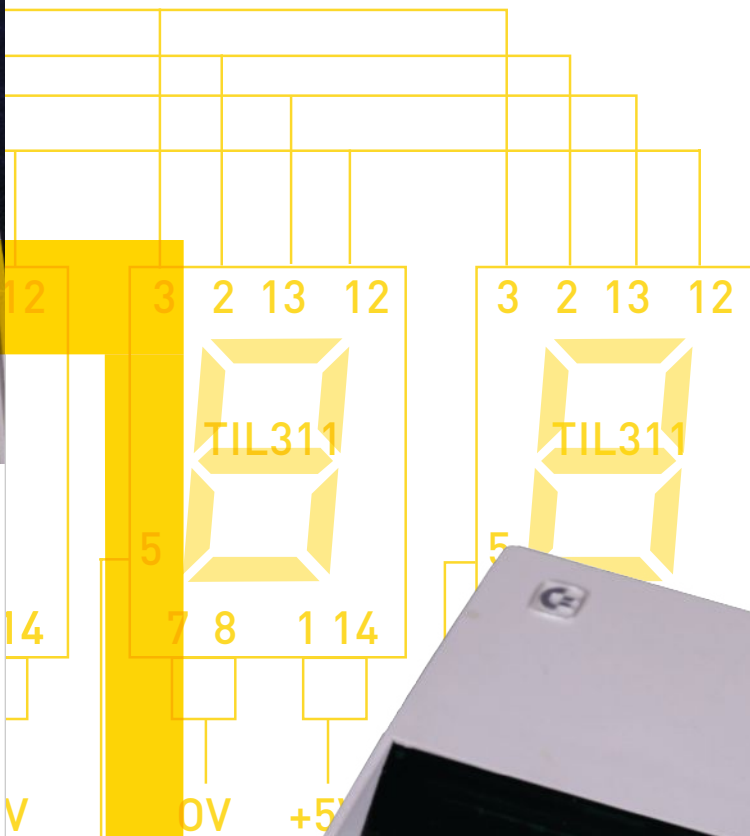

12

14

V

5

7

0V

+5V

→ 0V

I

SELECT 0-3/4-7

→ 0V



Don't think of it as a piece of old junk. Think of its vacuum fluorescent display becoming an eye-catching output device for a microcontroller.

FUN with FLEXIBLES

Tips to master the stretchy stuff Written by Matt Stultz



In the past few years, a flurry of new materials has hit the desktop 3D-printing market, enabling makers to do much more with their machines. We now have dissolvable support materials, plastics that simulate wood, stone, and metal, and even the start of conductive filaments. Flexible materials are another popular option, enabling stretchy, bendy, and rubber-like creations. As with all filaments, there are many different manufacturers and variations. Here's what it takes to get printing with flexible filaments.

Constrained Path Needed

The primary requirement for printing with flexibles is an extruder with a direct path that keeps the filament firmly in place from the time it leaves the drive gear until it enters the barrel of the hot end. This type of setup can be seen on the Printbot Alu Extruder, which has a metal guide after the drive gear to pass the filament directly into the heater barrel (Figure **A**).

Most extruders have been designed for use with stiff filaments that are pushed through the hot end by placing pressure on the filament

itself. This is problematic with flexible filaments, because their elastic nature makes it difficult to create the backpressure needed for extrusion.

Extruder Upgrades

Many extruders can be upgraded with parts found on YouMagine and Thingiverse that will allow you to print using your existing setup. In addition, LulzBot has created their own swappable Flexystruder (Figure **B**).

Print Hot

To help reduce the pressure required to push pliable filament through your hot end, it helps to run your extruder a little hot. Although vendors' suggested print temperatures vary, I tend to lean towards the higher numbers. Increased temperature makes the materials more liquid-like, allowing them to flow more easily through the nozzle. The downside is that the materials tend to ooze more when traveling. To solve this, increase the retraction distance in your slicer settings.

Take It Slow

Finally, make sure you print slowly (around 30mm/s). Printing fast can cause pressure to build up in your extruder. Flexible prints can also



MATT STULTZ

is a community organizer and founder of both 3D Printing Providence and HackPittsburgh. He's a professional software developer, which helps fuel his passion for being a maker. 3dppv.org

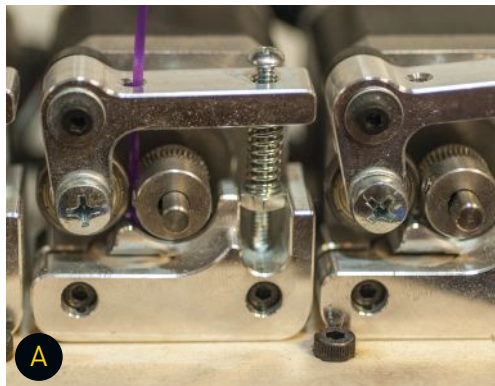

A

Printbot Alu Extruder

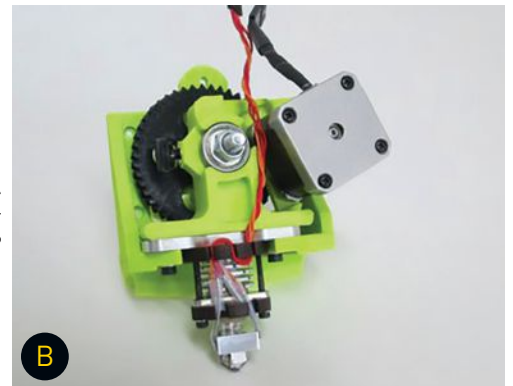

B

LulzBot Flexystruder

Caleb Kraft

Aleph Objects, Inc.

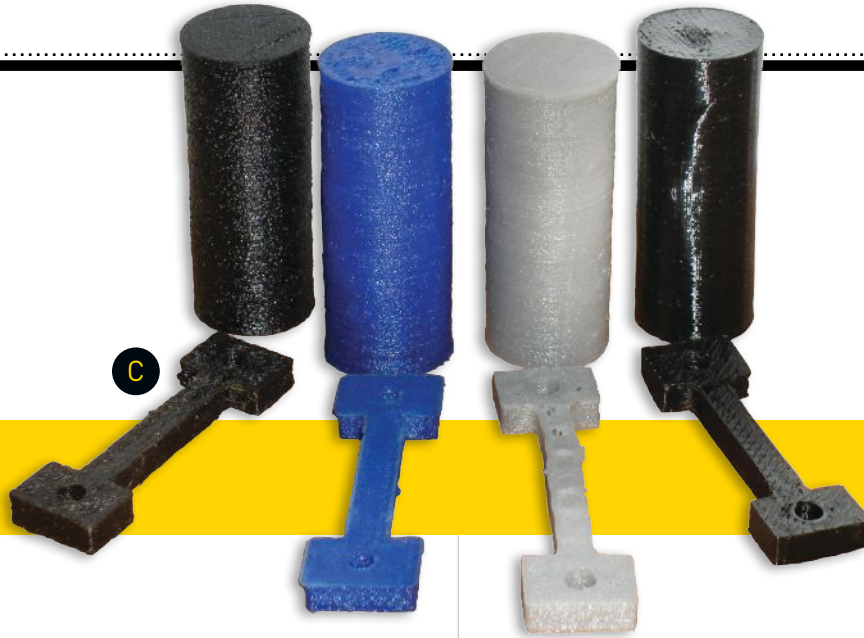

PRINT TEMPS AND SURFACES

These flexible materials print well on a cold bed with blue painter's tape at the following temperatures:

Filament	Temp	Website
Zen Toolworks Flexible	220°-230°C	zentoolworks.com
NinjaFlex	210°-225°C	fennerdrives.com/ninjaxflex
Filaflex	220°-230°C	recreus.com
Flex EcoPLA	210°-225°C	makeergeeks.com/flecnal.html

easily bend out of the way when a rapidly moving extruder passes by them, causing errors and poor print quality.

Testing and Measuring Flexibility

We tested four filaments that cover a great range of flex properties (Figure C). The materials tested were, from left to right: Zen Toolworks Flexible Filament, NinjaFlex, Filaflex, and Flex EcoPLA.

To better understand what "flexible" means in each case, we printed identical test objects using each filament, then conducted two experiments to measure different aspects of flex.

Crush Test

A cylinder measuring 20mm in diameter and 50mm tall was printed with two shells and a 10% infill. These were each placed in a sample holder attached on one side to a beam and on the other side to a scale and a weight. A bucket (acting as the weight) was slowly filled with water to increase the load until the print buckled and was crushed. Those weights were then recorded and the process was repeated to ensure accuracy.

Stretch Test

In this test a "dog bone" was printed with a 30mm×5mm×5mm center section. Each dog bone was loaded into a holder and a fixed weight of either 10kg or 4kg was placed onto the bottom holder to stretch the sample piece. After the weight was applied, the distance stretched was measured and the percentage stretched was calculated.

TEST RESULTS

Filament	Crush Test Weight	Stretch Test	
		10kg	4kg
Zen Toolworks Flexible	9.98kg	132%	124%
NinjaFlex	1.86kg	Over	262%
Filaflex	4.19kg	Over	327%
Flex EcoPLA	14.04kg	147%	181%

Final Thoughts

In the stretch test, both NinjaFlex and Filaflex stretched our test rig beyond its capabilities with 10kg, making them perfect choices for when you want super squishy and stretchy items.

The new Zen Toolworks filament and FlexPLA are great for printing objects that are bendable, but not very stretchy (such as timing belts).

While NinjaFlex seems to be the most popular currently (and adds some fun features, like being able to bond to PLA and ABS), all four of these materials could be useful to the resourceful tinkerer. 🛠️



Stretch test setup.

Matt Stultz



Crush test setup, post-crush.

Matt Stultz

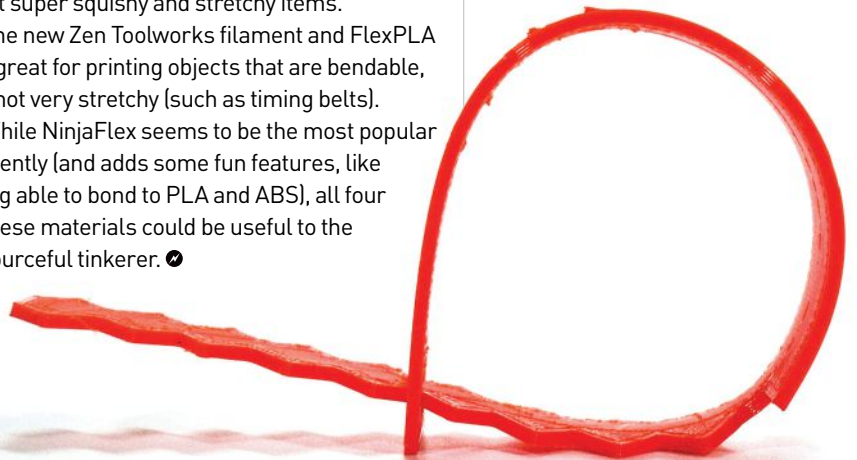

TOOLBOX

Gadgets and gear for makers

Tell us about your faves: editor@makezine.com



Milwaukee M12 Cordless Drill/Driver

\$99 : milwaukeetool.com

Milwaukee's 12-volt, $\frac{3}{8}$ " drill/driver is compact, its ergonomic grip feels natural, and it weighs only 2.5 pounds. The grip is so good, it almost feels like it was molded specifically for my hand.

This little drill packs so much punch that I actually accidentally torqued the heads off of a couple screws during testing. Dialing the adjustable clutch to a lower setting helped prevent that from happening again.

I also love the little battery fuel gauge LEDs, positioned just near the trigger, that give real-time status on the state of battery. There's also built-in intelligent battery protection that shuts power to the drill when it senses overload conditions, helping to preserve batteries over time.

I would highly recommend this drill for on-site jobs, and for the small-garage enthusiast working at a bench.

—Dan Spangler

Jeffrey Braverman



LAGUNA 14|TWELVE BAND SAW

\$1,097 : lagunatools.com

Laguna Tools, well known for their top-quality woodworking machines, has recently come out with a band saw that is geared toward the DIY/consumer market. The 14|Twelve is built with a powerful 1 $\frac{3}{4}$ HP motor, quick release blade tensioner, a polished 21" x 16" table, and an excellent fence.

With a throat capacity of 13 $\frac{5}{8}$ " (12 $\frac{1}{4}$ " with the fence) we find that the saw can handle all but the largest of our cuts. Like its more expensive siblings, the fit and finish on this machine are excellent. The saw's speed is optimized for wood, but with a bimetal blade and a little care we routinely cut $\frac{1}{4}$ " thick aluminum and acrylic, all sizes of wood, circuit boards, and pretty much anything else that needs cutting in our robotics shop.

—Robert Beatty

LEATHERMAN LEAP — A MULTI-TOOL FOR KIDS

\$54 : leap.leatherman.com

Leatherman engineers designed the Leap from the ground up to be a kid-friendly multi-tool for ages 9 and above. Kids who are into camping, making, and DIY activities will appreciate that this isn't a toy — it's a real multi-tool with real functionality.

Adult supervision is still needed, as the Leap contains serious tools, including a woodcutting saw. The Leap comes with a rounded-nose knife blade that can only be permanently installed by a parent if and when they feel their child is ready and responsible enough. Once the knife blade is installed, a two-handed opening method and molded grip help to promote safe and proper operation.

The Leap doesn't have any pinch points or sharp edges — at least none that we could find — and everything from the tool-opening tabs to the tool safety lock release buttons seem well designed for smaller hands and fingers.

—Stuart Deutsch

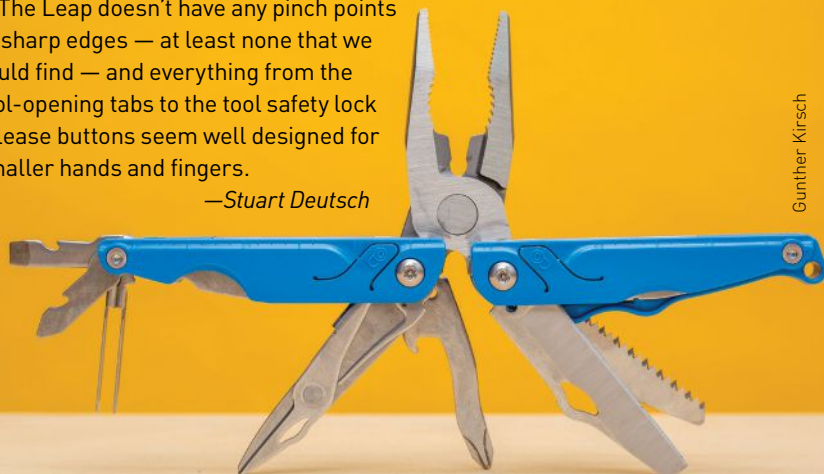

Gunther Kirsch



FLIR E4 THERMAL IMAGING CAMERA

\$995 : flir.com

The Flir E4 thermal imaging camera is a \$995 point-and-shoot device that is quick and easy to use. It has neither the resolution of higher-end models nor the high-end features or capabilities, but it provides a reasonably clear 80x60 pixel thermal image that is greatly augmented by Flir's MSX enhancement technology. The feature adds details and contrast from the simultaneously captured visual image to provide a composite thermal image that looks a lot better than the E4's resolution specs suggest it's capable of.

—SD

NORD-LOCK “WEDGE-STYLE” WASHERS

\$13 for a pack of 20 (smaller sizes): nord-lock.com

If your project involves motors or motion, like with rolling, walking, or flying contraptions, you should pay extra attention to the fasteners you use. Vibrations can shake parts loose, even if nuts and machine screws feel tight and secure at first.

Nord-Lock’s wedge-style washers go between fasteners and the hard components they are threaded through or into to create a virtually vibration-proof joint. While I still regularly check fasteners that have the potential to be shaken loose, I have found that Nord-Lock washers work remarkably well to keep critical joints tight and secure. They’re about as “set and forget” as it gets.

—SD



BETTER THAN VELCRO SCOTCH EXTREME FASTENERS

\$ varies : mounting.scotchbrand.com

Instead of scratchy hooks and fuzzy loops, 3M’s patented Dual-Lock fasteners have the same interlocking “nail-head” shape on both sides. I like it because it’s stronger (holds 2lbs/in²), it’s less snaggy on fabrics, and I’m betting it’s more durable too, as the nail-head shapes look way more robust than hooks and loops which eventually shred and fail. 3M also sells traditional hook-and-loop fasteners — so look for their Scotch Extreme and Outdoor lines to find the Dual-Lock stuff.

—Keith Hammond

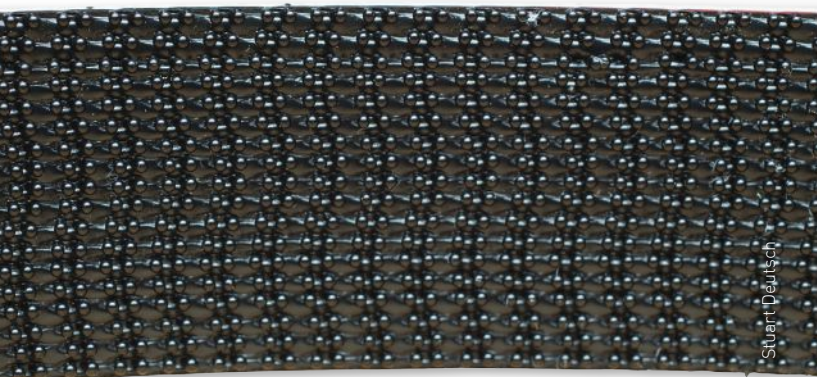

Stuart Deutsch

NEW MAKER TECH



INTEL EDISON

\$75 including breakout : makershed.com

Intel just started shipping Edison, their postage stamp-sized Linux computer-on-module platform. The board itself has some powerful specs: a dual core, dual threaded 500 MHz Atom processor and a 32-bit, 100 MHz Quark microcontroller for real-time functions. It has 1 gigabyte of RAM, 4 gigabytes of on-board flash memory, wi-fi, Bluetooth, and 40 GPIO pins for interfacing with your own hardware.

To get you started, Intel offers two breakout board options: one that has Arduino pin compatibility; and another that is much smaller for more advanced hardware developers. The company expects makers to use this tiny computer to create Internet of Things and wearable computing products. —Matt Richardson

Jeffrey Braverman

LOGI-PI

\$90 : element14.com

While they’re quite powerful, getting started with FPGA development boards has its hurdles. In fact, setting up the development environment is often no easy task. Thanks to the LOGi-Pi add-on board for Raspberry Pi, you can get up and running in no time. Its Spartan-6 LX9 chip is great for applications such as real-time robotics control or computer vision. Not only do the developers of the LOGi-Pi provide a few open source examples to get you started, but they also offer API’s and wrappers so that you can program using C, C++, or Python. The board even has an Arduino pinout so that you can use LOGi-Pi with the shields you already have.

—MR

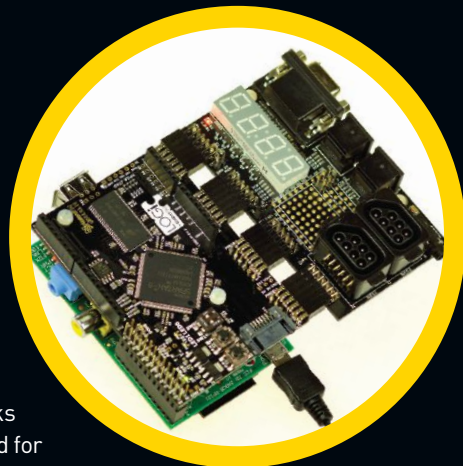

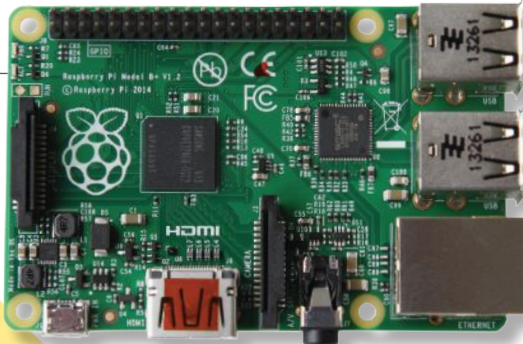

RASPBERRY PI MODEL B+

\$35 : element14.com

In a recent development that we expect will delight makers, the Raspberry Pi Foundation has released a revision of their flagship product. The new Raspberry Pi Model B+ offers a few improved features over the Model B, which will continue to be available. The Model B+ has four USB ports instead of two and improved power circuitry. Its 40-pin connector breaks out additional GPIO pins, allowing you to connect more components to the Pi. Smaller differences include rounded corners on the board itself, a microSD card slot, and a single jack which carries the analog audio and video signals. The CPU and memory remain unchanged, as well as the board's low price.

The new model also supports Raspberry Pi's HAT specification, which defines the way expansion boards should be designed. The spec includes an automatic configuration method that allows users to add hardware easily with no need to load drivers or reconfigure their boards.

—MR

RPLIDAR

\$399 : robopeak.com

LIDAR is like radar but uses a laser instead of a radio beam to sense distance. Pro-level applications include mapping terrain from orbit and keeping autonomous cars from running off the road.

This little guy mounts an invisible near-infrared laser (operating at eye-safe power levels) next to a detector, on a rotating head, with electronics that read the time required for laser pulses to bounce back from walls and other obstacles 2,000 times per second. The head speed can be adjusted to complete between one and 10 rotations in that time. Spinning slower gives better angular resolution but a slower refresh rate. Max range is about 20', though this will vary with the reflectivity of nearby targets.

The software produces a 2D "flatland" map of vertical obstructions and is mostly intended for use in so-called SLAM (Simultaneous Localization and Mapping) applications for indoor robots — basically building a real-time map of the surroundings and locating oneself within it. Theoretically, you could probably tilt or translate on the Z-axis and collect contours to build full 3D scans, but there's a lot of coding between here and there.

—Sean Ragan



BOOKS

MACHINERY'S HANDBOOK (29TH EDITION)

By Erik Oberg
\$65 ToolBox, \$85 Large Print (street prices) : Industrial Press



The *Machinery's Handbook*, currently in its 29th edition, is an engineering reference that covers many metalworking, machining, fabrication, manufacturing, and mechanical design topics. It is full of encyclopedic information, calculations, charts, and standards that might be difficult to find anywhere else, at least in such a concise and easily digested manner.

In today's age, it is common to look toward the internet for reference material, but unfortunately there is a lot of incomplete information out there. If you are doing any kind of fabrication work, whether on the serious hobbyist level or production level, you really need this "Bible of the Metalworking Industries" on your bookshelf.

There are two print sizes — a compact "toolbox" edition and a regular sized "large print" edition.

—Stuart Deutsch

HOWTOONS: TOOLS OF MASS CONSTRUCTION

By Saul Griffith, Ingrid Dragotta, and Nick Dragotta
\$15: Image Comics

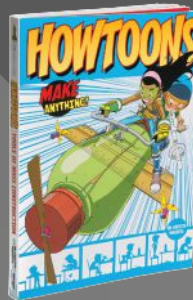

You could probably tell from the cover image that *Howtoons* is a how-to and educational comic that is primarily intended for a younger audience. But what you cannot tell from the cover is that the book is filled with comedy, fantastic illustrations, wit, creative and clear presentations of scientific concepts and engineering principles, and of course some great kid-friendly projects.

Howtoons follows the adventures, projects, and antics of siblings Celine and Tucker, and is a great read that is fun and educational without being the least bit boring.

If you have enjoyed any of the *Howtoons* comics that appeared in past issues of *Make:* magazine, you will love this book.

—SD

BORG LIKE ME

By Gareth Branwyn
\$27 : Sparks of Fire Press

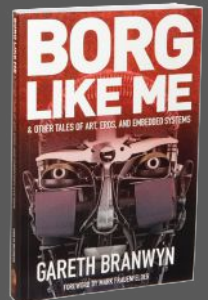

Gareth Branwyn was one of the first writers I read who made me realize that I really could "do it myself."

Reading *Borg Like Me*, Branwyn's collection of his greatest and most personal stories, feels like sitting in a bar with your most interesting friend. One minute he's talking about the Church of Slack, the next it's Billy Idol's answering machine. You have no idea how he connects each topic to the last, but it all flows, and is fascinating and deeply candid. You want to find out more about everything he mentions, and woven through it all is the spirit of William Blake. You may have no idea who this Blake guy is, but it's clear you've got to find out more about him, and everyone else in the book. That's the magic of Branwyn and of *Borg Like Me*.

—Tom Igoe

Can your 3D prints do this?



NinjaFlex® Flexible 3D Filament opens a world of possibilities, limited only by your imagination.



FLEX YOUR 3D IMAGINATION.



Learn More at NinjaFlex3d.com

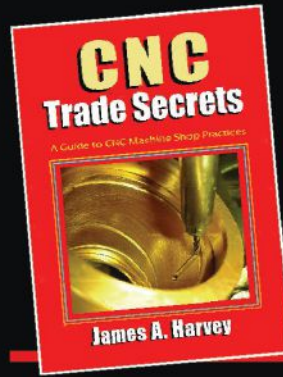

You CAN ...
DO IT YOURSELF!

WITH TIPS FROM A MASTER MACHINIST AND VETERAN OF THE TRADE

2014, 180 pgs, Illustrated, 978-0-8311-3502-7, \$29.95

This guide is packed with practical "how to" information that introduces you to the world of CNC, helping you become familiar with CAD, CAM, G-codes, and CNC machines. Perfect for the shop owner, machinist, or hobbyist! Also available as an ebook.

FEATURES YOU'LL FIND

- ◆ Over 100 4-color photos throughout.
- ◆ Easy-to-read steps for going from print to part
- ◆ Useful techniques for holding and machining parts using CNC machines
- ◆ Ways to unravel the mysteries of using G-code
- ◆ Ways to avoid "Crashing"
- ◆ 3D CNC milling basics
- ◆ What CNC machines can and cannot do

RECEIVE A 30% DISCOUNT WHEN YOU PLACE YOUR ORDER BY 1/31/15*. PROVIDE SPECIAL OFFER CODE MAKE2014 WHEN ORDERING. * AVAILABLE TO U.S. RESIDENTS ONLY. OFFER NOT AVAILABLE TO RESELLERS.

INDUSTRIAL PRESS INC.

32 Haviland Street ◆ South Norwalk, CT 06854 ◆ Phone: (212) 889-6330
Email: info@industrialpress.com ◆ Web: www.industrialpress.com

YOU HAVE A SPACE.
YOU HAVE SOME TOOLS.
NOW WHAT?

MAKERSPACE OPERATIONS BOOTCAMP

LEARN SYSTEMS FOR SMOOTH AND SAFE OPERATION

Join the founders at Maker Works for this inspiring 5-day workshop which covers the tools and strategies you need to run a safe and sustainable makerspace.

maker-works.com/mob ◆ Space is limited!

NEXT BOOTCAMP: MON, JAN. 26 - FRI, JAN 30, 2015

MAKER WORKS



Ann Arbor, MI | Ph: 734-222-4911 | membership@maker-works.com

The new EAGLE has landed!

Version 7

now available



For more information, visit www.cadsoftusa.com

pcDuino  LinkSprite

Yes, it is true!

pcDuino3 for \$59.99
pcDuino3 Nano for \$39.99
pcDuino3 Core for \$29.99

Coming soon

- Freescale Four Core PcDuino Acadia
- Allwinner Eight Core PcDuino8

pcduino.com store.linksprite.com

3D printers should have a diet high in
CARBON FIBER



EXOTIC FILAMENT BY PROTOPLANT

www.proto-pasta.com

USE THE CODE "MAKE" & GET 20% OFF

 velleman[®] Inc.



K8200 3D PRINTER KIT

| 1/16" (3 mm) filament (PLA & ABS)
single feed

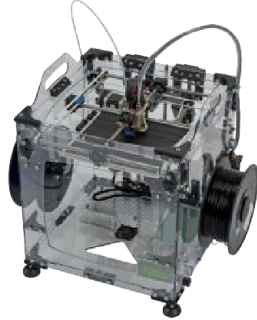

K8400 3D PRINTER KIT

| 1/16" (1.75) mm filament (PLA & ABS)
dual feed



3DPENU 3D DRAWING PEN

| 1/16" (1.75mm) PLA



FOLLOW US
ON TWITTER!

www.vellemanusa.com

FOLLOW US
ON FACEBOOK!



**COMPOSE
INVENT
CODE
CREATE**

Ignite creative thinking.

THE
EXPERIMENTORY

JULY 2015

experimentory.com / A summer program
for students entering seventh and eighth grade

You control the Holograms now.

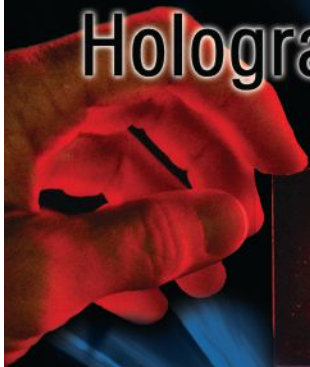

HOLOGRAM KIT

Create real 3-D holograms with the Litiholo Hologram Kit! Complete with "Instant Hologram" film and everything you need to create up to 20 different holograms.

Litiholo
www.litiholo.com

Scan here to see a video of real holograms in action!



WORLD'S MOST VERSATILE CIRCUIT BOARD HOLDERS



Model 324

Our Circuit Board Holders add versatility & precision to your DIY electronics project. Solder, assemble & organize with ease.



Model 201

VISIT US ON

MONTHLY CONTEST

Visit us on Facebook® to post a photo of your creative PanaVise project for a chance to win a PanaVise prize package.

PANAVISE®
Innovative Holding Solutions

7540 Colbert Drive • Reno • Nevada 89511 | (800) 759-7535 | www.PanaVise.com



ESUN 3D FILAMENT

- PLA ABS HIPS WOOD CHANGE CLEANING
- PETG PVA FLEXIBLE CONDUCTIVE NYLON

[ACCEPT CUSTOMIZED]



ENVIRONMENT-FRIENDLY **STEADY QUALITY**
FUNCTIONAL DIVERSITY **ECONOMICAL PRICE**



Esun: bright@esun3d.net +86-755-26031978
 Esun distributor in FL: sales@knkusa.com +140-7701-4830
 Esun distributor in CA: sales@toybuilderlabs.com +162-6808-4010
 Website: www.esun3d.net

ALL ELECTRONICS CORPORATION

Thousands of Electronic Parts Available Today!

- LEDS • CONNECTORS • RELAYS
- SOLENOIDS • FANS • ENCLOSURES
- MOTORS • WHEELS • MAGNETS
- PC BOARDS • POWER SUPPLIES
- SWITCHES • LIGHTS • BATTERIES
- and many more items...

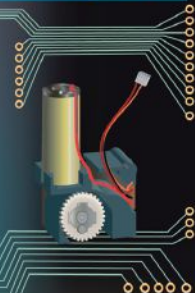

We have what you need for your next project.



www.allelectronics.com
Discount Prices • Fast Shipping

Make:

OVER THE TOP

“Château de Rudenko”

Written by James Burke

AGAIN? NO. SERIOUSLY? IT’S GOT TO BE THE SAME ONE.

It’s not? Look, I’ve been running for days. I’m not tired, it’s just the castles — they’re all the same! Identical turrets with narrow sawtooth battlements, minimal ramparts with thin arrow loops, and each structure features a distinct lack of plumbing. Also, I don’t think I’ve ever seen a guard here. (Or anybody for that matter.) What sort of economy supports this scale of production and such lax protection? It’s supposed to be a fortress, not an invitation to royal abduction. All I had to do was grab the flag.

I did find the builder. Hailing from the deep forests of Shorewood, Minnesota, is Andrey Rudenko, who, unlike my brother and everyone else I’ve ever known, seems to have greater than 8-bit resolution.

He’s unable to jump four times his height and he can’t shoot fireballs after consuming local flora. Despite these shortcomings he’s a talented engineer who managed to build a 3D printer to erect this edifice. Using a special mixture that is almost like a fine concrete, he printed and assembled the castle over the course of a couple weeks (not counting rain and zoning delays). The home-fabricated printer can scale to the size of a two-story structure and Rudenko’s aspiration is to use it to build houses.

The Château is quite impressive, even if it fails to protect royalty from every foe I’ve had to stomp on to get here. Rest assured: When I find Peach I’m going to let her know that she needs to get out of the real estate business and hire some more security. 🍷



Andrey Rudenko

Introducing the

 **DREMEL[®] 3D**
IDEA BUILDER



Easy to use straight out-of-the-box, you're ready to start building anything you need, anything you want, or anything the world has been waiting for. Build on Dremel Maker, build on.

Visit Dremel3D.com for details.





FOR 3D PRINTERS BY 3D PRINTERS

IC3D Filament is...

Engineered Exclusively for 3D Printers
Manufactured in Ohio, USA
100% Satisfaction Guaranteed
Visit Us At...

www.ic3dprinters.com



© 2014 IC3D LLC. All rights reserved. IC3D, the IC3D logo, and "For 3D Printers, By 3D Printers" are trademarks of IC3D LLC, registered in the U.S. and other countries.

US \$9.99/CAN \$9.99
ISBN: 978-1-457-18385-0

